

*The*

# SHORT WAVE

*Magazine*

25p

VOL. XXXI

JULY, 1973

NUMBER 5



**WORLD WIDE COMMUNICATION**

# LOWE ELECTRONICS

119 Cavendish Road, Matlock, Derbyshire, DE4 3HE

Tel. Matlock 2817 or 2430 9 a.m. - 9 p.m.

John: G3PCY

Bill: G3UBO

Alan: G3MME

MAIN DISTRIBUTOR FOR YAESU MUSEN EQUIPMENT

Hours: Tuesday to Saturday 9-5.30 (closed 1-2 and all day Monday)

**SERVICE AND SALES (evenings and weekends only) ; John G3JYG, 16 Harvard Road, Ringmer, Lewes, Sussex. Tel. Ringmer 812071. Sim GM3SAN, 19 Ellismuir Road, Baillieston, Nr. Glasgow. Tel. 041-771 0364. Alan GW3YSA, 35 Pen y Waun, Efail Isaf, Nr. Pontypridd, Glam. Tel. Newton Llantwit 3809. Peter Ward, G3XWX, 47 Radstock Avenue, Ward End, Birmingham B36 8HD.**

Sim, John, Alan and Peter will be happy to demonstrate New Yaesu Gear by appointment. They also have a pretty good selection of second-hand trade-ins at the right price.

## SPECIFICATIONS

<b>Frequency Range</b>	80m. 3.5-4.0 mc/s. 40m. 7.0-7.5 mc/s. 20m. 14.0-14.5 mc/s. 15m. 21.0-21.5 mc/s. 10m. 28.0-29.2 mc/s. WWW 10.0-10.5 mc/s.
<b>Sensitivity</b>	CW SSB Less than 0.5 $\mu$ V for 10dB S/N ratio AM Less than 1 $\mu$ V for 10dB S/N ratio
<b>Selectivity</b>	$\pm 1.8$ kHz at -6dB ; $\pm 5$ kHz at -50dB
<b>Image Rejection</b>	More than 50dB
<b>Calibrator</b>	100 kHz (crystal optional)
<b>Audio output</b>	1.5w 4 ohm, 600 ohm, speaker built-in
<b>Power source</b>	110 ; 117 ; 220 ; 234v. A.C.
<b>Dimensions</b>	13" wide, 6" high, 10 $\frac{1}{2}$ " deep
<b>Weight</b>	17 $\frac{1}{2}$ lbs. approx.



The FR50B is without any shadow of doubt the best amateur band receiver you can buy at anywhere near the price. Take, for example the r.f. amplifier; for wide dynamic range it is true to say that a good valve will still beat a good transistor, and of the valves available, the 6BZ6 as used in the FR50B is probably the best for the purpose. This is followed by a 12AT7 triode mixer which shows its superiority over multi grid mixers in terms of lower noise while maintaining good conversion gain. Typical of the Yaesu thoroughness in design is the use of a tapped IF transformer, to provide correct impedance matching to the mixer.

In contrast to r.f. and mixer stages, the oscillator stage is one in which transistors can outperform valves. Stability is all important and the absence of heat and microphony in a transistor allied with its long-term gain and internal capacitance etc., stability, makes it an ideal choice for an oscillator. Needless to say Yaesu use transistor V.F.O.'s in all current equipment. Isolation of the VFO from following stages is essential to avoid oscillator pulling. Yaesu achieve this in the FR50B by use of an emitter follower stage.

In common with many receivers intended for use with a companion transmitter, a VFO output socket is provided on the rear chassis. I wonder how many people realise what a fruitful source of I.F. breakthrough such an output can be. The FR50B incorporates an I.F. trap in this output, thus neatly minimising breakthrough from this source. Another example of Yaesu attention to detail.

The 2nd oscillator is crystal controlled for unconditional stability and is unusual in that a double tuned transformer is used in the feed to the mixer to prevent harmonic mixing.

Ceramic transistors are used for I.F. selectivity having the advantage of long term stability and ease of alignment using a minimum of test equipment.

For easy resolution of SSB, a product detector is essential and the FR50B 6BE6 product detector used with separate BFO injection gives excellent performance without overload. The tunable BFO is a blessing for the CW man, allowing him to vary pitch without retuning the receiver.

A point which is often overlooked is the importance of isolating the BFO from the AGC system. Inadequate isolation allows the BFO signal to generate an a.g.c. voltage which of course reduces receiver gain. This

problem does not occur in the FR50B due to the use of a separately excited 6BE6. An unusual feature for a receiver in this price class is the provision of both fast and slow a.g.c.

The A.F. amplifier section has overall negative feedback applied which results in a standard of audio quality not often found in a communications receiver.

When operating transceive with a companion transmitter, an adjustable monitor control allows a continuous check on the transmitted signal.

Easy resolution of SSB signals require a slow tuning rate and this is achieved by using the same high quality gearbox as on the wellknown FR100B with its 1 kHz readout.

Good though the FR50B undoubtedly is some of our Customers have commented that it would be nice to have both top band coverage and the whole of 10m for converter use. Therefore as part of our normal Customer service we have developed suitable modifications to provide both these facilities.

For Customers wishing to have their new FR50B modified by us, the price is as follows (and it includes carriage by Securicor and V.A.T.):  
Standard FR50B ... £71.50 28-30 MHz coverage £2.75  
Calibrator Crystal ... £2.75 160m. plus 28-30 MHz £7.50  
160m. coverage £5.50

We can, if you wish, fit the 2m. converter for you, and have no hesitation in recommending the Weir Mosfet Converter, which we can supply ready fitted for £22.

With these modifications, you have a receiver, which, at the price, is UNBEATABLE.

It should be fairly clear from the foregoing that Lowe Electronics give you a bit more than anyone else.

When it comes to Yaesu equipment Lowe Electronics have more know how than anyone else.

When it comes to Service, Lowe Electronics again give you more than anyone else.

Our Customers know this, expect it and get it. It is simply that every now and again we have to remind you that for some years now we have been the best, we are still the best, and we intend to continue to be the best.

**ANTENNAS**

<b>2m "J"</b>	<b>Beams 50 or 75 ohms (specify which)</b>	
2/4Y	4 element folded dipole Yagi with 1" boom	£3.74
2/6Y	6 element folded dipole Yagi with 1" boom	£4.40
2/8Y	8 element folded dipole Yagi with 1" boom	£5.17
2/10Y	10 element folded dipole Yagi with 1 1/4" boom	
	and 45 Braces	£10.45
2/10XY	Crossed 10 element Yagi with 1 1/4" boom	£13.84
2/14P	14 element Parabeam	£16.28
2/12	6 over 6 with 1" booms	£7.97
2/16	8 over 8 with 1" booms	£9.79

<b>2m. Mobile Whips</b>		
Diamond DP-25	gutter mounting & vertical	£11.55

<b>G-Whips</b>		
Tribander (20, 15 and 10m.)		£12.10
Multimobile 20, 15 and 10m.		£14.30
160, 80 or 40m. coils for above, each		£4.40
Top whip section for above		£1.10
Flexiwhip 10m. with whip		£9.35
160, 80, 40, 20 or 15m. coils, each		£4.67
Ranger 160m.		£9.35
Duobander 160/80m.		£10.45
Base section for all G-Whips		£1.60

The above are normally sent British Rail—should you require 24 hour Securicor delivery, please add an extra £1.50.

<b>H.F. Beams</b>		
AS-203W	wide spaced 3 element 20m. beam	£72.60
AS-154W	wide spaced 4 element 15m. beam	£48.40
AS-153W	wide spaced 3 element 15m. beam	£38.50
AS-104W	wide spaced 4 element 10m. beam	£40.00
AS-103W	wide spaced 3 element 10m. beam	£22.00
Polygon	2 element glass fibre kit	£38.50

<b>Verticals</b>		
Diamond DP-KB103	80 and 40m.	£27.50
DP-KB104	20, 15 and 10m.	£20.90
DP-KB105	80, 40, 20, 15 and 10m.	£38.50
Asahi Echo 8G	40, 20, 15 and 10m.	£22.00

<b>Antenna Accessories</b>		
Coax UR43	50 ohm	m 10p
Coax UR67	50 ohm	m 27p
Twin feeder	300 ohm	m 6p
Twin feeder	75 ohm	m 6p
Rotator cable	4 core (AR22)	m 18p
Rotator cable	12 core (TR44 and Ham-M)	m 35p
Baluns HZP (1:1 or 4:1)		£5.50
Rotators AR22R		£27.50
TR44		£49.50
Ham-M		£77.00
<b>SWR Meters</b>		
Hansen	single meter	£5.50
Asahi	twin meter	£8.80
Diamond SR-435	(VHF/UHF)	£15.40
Dummy load/wattmeter	(VHF/UHF)	£38.50
PL259 plugs	33p Reducers	10p
Sockets	33p Line Connectors	80p

<b>Station Accessories</b>		
Plain brass	morse keys	£1.35
Katsumi	keys EK-9X	£9.90
Katsumi	keys EK-108A (mains)	£29.70
Katsumi	keys EK-108D (battery)	£26.40
C.V.	practical oscillators	£2.75
Headsets,	low impedance, padded	£3.30
Microphones	Yaesu YD844 table mike	£14.30
	Yaesu YD846 hand mike	£5.50
	DM501 hand mike	£3.75

<b>Valves</b>		
6AH6, 6BZ6, 6CB6A, 6CL6, 6UBA, 6EW6, 6EW6, 6EH7,		
6BM9, 12BY7A, each		66p
6GK6		£1.22
6JM6A		£1.65
6JS6C, 6KD6, each		£2.20
6146B		£3.30

**FILTERS**

<b>Crystal</b>		
S.E.I. QC1246AA	5.2 MHz SSB filter	£17.82
S.E.I. QC1246AZ	9.0 MHz CWV filter	£18.40
S.E.I. QC1246AV	9.0 MHz SSB filter 2.5 kHz	£11.00
S.E.I. QC1246AX	9.0 MHz SSB filter 2.4 kHz	£15.40
Yaesu FT101	CWV filter	£17.60
S.E.I. FT101	AM filter	£19.80

**Mechanical**

Kokusai MP455	3AZ CW filter	£15.00
Kokusai MP455	10AZ SSB filter	£15.00
Carrier	crystals for the above filters, each	£2.50

Remember that all prices include V.A.T. and postage, so you do not have to send extra.

**PRICE LIST APRIL 1973**

Price including VAT

**YAESU MUSEN**

FR400SD	£192.50	FV200	£46.20
FL400	£181.50	FL2000B	£181.50
SP400	£12.10	FL2100	£181.50
FT401	£291.50	FR50B	£71.50
FV401	£46.20	FL50B	£82.50
SP401	£12.10	FV50B	£30.80
FT101	£308.00	FT501D	£319.00
FP101	£46.20	FP501	£49.50
SV101	£12.10	SIGMASIZER	£198.00
FT75	£126.50	YC35SD	£132.00
FP75	£27.50	FT2FB	£107.80
DC75	£27.50	FT2AUTO	£172.70
VC75	£24.20	FT101 FAN	£9.90
FV50C	£30.80	FT101 CW FILTER	£17.60
FT200	£159.50	YD844	£14.30
FP200	£49.50	YD846	£5.50
DC200	£59.40		

\*FT2AUTO fitted 5 channels. Extra channels £3.32

**KARL BRAUN**

SE600 DIG	£627.00	SE600	£544.50
SE280	£242.00	DGTC 22	£24.20
DGTC 1702	£42.90	LVV 270	£41.80
TTY 1270	£29.15		
Linar 2	£151.50	Wair Mosfet Converter	£15.00

Prices include carriage by Securicor except speakers and microphones which are mailed.

**SECOND-HAND EQUIPMENT**

(Prices include VAT)

All mint, checked, serviced and aligned unless specifically stated otherwise

<b>Receivers</b>		
Sommerkamp FR500 SDL		£125.00
Sommerkamp FR500		£95.00
Eddystone 680X		£65.00
Trio JR599		£150.00
National NC303		£99.00
Eddystone 770R		£99.00
Collins 5134		£198.00
Eddystone EC10 Mk. 2		£60.00
Trio JR310		£72.00
Trio 9R59DE		£38.50
Hammarlund HQ170A		£82.00
Lafayette HA350		£55.00
Trio 9R59DS		£44.00
Trio JR500S		£52.00
AR88D		£44.00
Yaesu FR400 SDL		£135.00
Heath GR78		£66.00
Eddystone 940		£104.00

<b>Transmitters</b>		
DX40 + VFO. Choice of two		£22.00
FL500		£115.00
Labgear Topbander		£15.00
Hallicrafters HT40		£15.00
KW Viceroy IV. Minc		£77.80

<b>Transceivers. All with p.s.u.'s unless clearly stated</b>		
Yaesu FTdx500		£176.00
KW2000B. As new		£176.00
Yaesu FT101 with 160m.		£215.00
Heath HW100		£110.00
KW2000A + A.C. p.s.u. Choice of two		£165.00
Heath SB101		£165.00
KW2000 with both p.s.u.'s		£110.00
Trio TS510 remote VFO and fitted CW filter		£155.00

CARRIAGE BY SECURICOR £2.00 EXTRA

**LOWE ELECTRONICS**

119 CAVENDISH ROAD, MATLOCK, DERBYSHIRE, DE4 3HE

TEL. MATLOCK 2817/2430

MEMBERS OF THE AMATEUR RADIO RETAILERS ASSOCIATION

# NORTH WEST ELECTRICS, G3MAX

769, STOCKPORT ROAD, LEVENSHULME,  
MANCHESTER, 19.

Phone: 061-224 4911

**EDDYSTONE RECEIVERS & DIECAST BOXES.  
TRIO RECEIVERS. JACKSON CAPACITORS &  
DRIVES. DENCO COILS.**

**PLUS 10% V.A.T.**

**CABINET FOR FREQUENCY COUNTER.** 12" x 3" x 6"  
with cut out to suit 8 digit readout. Ventilation louvres. Silver  
grey stove enamelled, £3.25, post 25p.

**FIBRE GLASS BOXES.** With fitted ali. panel, 9" x 4" x 3",  
£1.40. 5½" x 3½" x 4", £1.25. 5¼" x 2½" x 2", 38p. Postage 10p  
each.

**DIECAST BOXES.** With fitted lid. Post 10p per box.

Cat. No. 7969P 3½" x 1½" x 1 7/32",	39p
Cat. No. 7134P 4½" x 2½" x 1",	46p
Cat. No. 6908P 4½" x 3½" x 2",	65p
Cat. No. 6827P 7½" x 4½" x 2",	£1.04
Cat. No. 6357P 7½" x 4½" x 3",	£1.13

Sizes shown are approx. internal dia.

**ALI. MINI BOXES.** With fitted lid. Post 5p per box.

3" x 2" x 1" , 33p	5½" x 4" x 1½", 43p
4" x 2½" x 1½", 38p	4" x 2½" x 2", 38p
4" x 4" x 1½", 38p	5" x 2½" x 1½", 38p

**FINNED ALUMINIUM HEAT SINKS.** 5" x 2" ready drilled  
for TO3, 25p. 5" x 4" undrilled, 37½p. 5" x 8", undrilled, 65p,  
post 10p.

**POLYPROPYLENE ROPE.** 500 lb. Strain. 100 yd. reel, £1,  
post 15p. (This item is now in stock).

**DENCO COILS.** Most ranges in stock, 40p ea., post paid.

**PULSE GENERATOR LBR2.** 50uS, 100uS, 200uS, 500uS, 1mS,  
2mS, £18, carriage by arrangement.

**MARCONI OSCILLATOR TF 1246.** 40 kHz to 50 MHz with  
handbook, £40, carr. £2.

**Business Hours :** Tuesday-Friday, 9.30 a.m. to 6.00 p.m.

**SATURDAY :** 9 a.m.-5 p.m. **OPEN ALL DAY**

**CLOSED ALL DAY MONDAY**

## COMPONENTS

### FOR FREQUENCY COUNTERS & CLOCKS

**NEW BOARDS MANUFACTURED TO OUR  
SPECIFICATION, COMPONENTS NOT INCLUDED  
IN PRICE OF BOARD.**

**8 DIGIT READOUT BOARD ASSEMBLY, £4.50,** post  
10p. Printed to use ZM1020 1" dia. end readout tubes. Front  
board takes holders for ZM1020s and 74141N Nixie drivers.  
Back board takes 7490 and 7475 Quad latch. Boards mount  
back to back to make an ideal assembly for frequency counter,  
etc. Board size : 10" x 2½".  
Front or back board available, £2.25 ea.

**READOUT BOARD.** 4 Digit, uses GNP7 wire ended, side  
viewing tubes. 7490 dividers, 7475 latch and 74141 Nixie driver.  
Printed for reset 0, can be wired to reset 9. Size : 4½" x 3".  
£1.50, post 5p.

**GNP7.** Wire ended side viewing. A7001 Wire-ended side viewing,  
£1.50 ea. Post Paid.

**TIME BASE BOARD.** Gives all pulses needed to control readout  
for counter. Uses 7400 Osc. 1 MHz. 6 off 7490 Divider chain to  
1 cycle. 7474 clocked dual D, 7413 Schmitt trigger. 7400 pulse  
outputs. 2N3708 latch output. Size : 4½" x 2½". Use BC107 to  
drive 8 latches, £1.50, post 5p.

**PRINTED BOARD FOR 72710N** op amp. Counter front  
end. 2½" x 1½", 45p, post paid.

**PRINTED CIRCUIT HOLDERS FOR ZM1020, 28p** each,  
post 5p. 8 way ribbon cable for connecting boards, 20p yd.,  
post 5p. yd. (8 x 4" sections required for linking boards.)

**READOUT TUBES.** ZM1020 1" dia. end viewing, £1.50 each  
with holder, 4 for £5, post paid. Supplied with Chassis or  
printed circuit holders.

**DIGITAL CLOCK BOARD.** 4 digit 12 hour. Uses 7 off SN7490's,  
1-SN7413, 3-SN74141, 1-C407. Printed to use A7001 midgeet  
side viewing tubes, £1.50, post 5p. 4½" square.

**A7001 TUBES.** Full set of parts for 12 hour clock, £20, post paid.

**NEW TEXAS I.C.'s.** 7400, 22½p; 7413, 40p; 7490, 86p;  
7474, 45p; 74141, £1.12; 7475, 55p; 72710, 46p; 72741, 75p.  
SN74176 35 MHz Counter, £1.50; SN7410, 25p; SN7430, 27p.  
Post 5p each.

**ALL BOARDS ARE HIGH QUALITY PRINT ON FIBRE GLASS.  
HOLDERS FOR I.C.'s.** Low profile 14 or 16 pin, 15p each, postage  
5p each and including up to 5 off.

**WE WELCOME ALL ENQUIRIES HOWEVER SMALL**

*Stamped address envelope please for special offer list.*

**MEMBER OF THE AMATEUR RADIO RETAILERS ASSOCIATION**

# Heathkit 2 Metre FM Equipment

**All solid-state design. Can be completely aligned without instruments.**

**Multi-channel capability**—independent pushbutton selection of 6 transmit and 6 receive crystals.

**10-Watts Minimum Output**—designed to operate into even an infinite VSWR without failure.

**Optional Tone Burst Encoder**—mounts inside, gives front-panel selection of four presettable tones.

**Available with a full-line of accessories**—for both mobile and fixed operation.

**Includes push-to-talk mike**—ceramic tailored-response microphone provides outstanding audio transmission.

**Kit K/HW-202 £89.10 Carr. 66p (VAT £8.16 incl.)**



**HW-202**



**HA-202**

## New Heathkit 2-metre FM Amplifier, HA-202

40 watts nominal out for 10 watts in—requires only 12v. D.C. supply. Perfect match for the HW-202 Transceiver—also gives fully automatic operation with any 2-metre exciter delivering 5-15 watts drive. Solid-state design—all components mount on single board for fast, easy assembly.

**Kit K/HA-202 £38.50 Carr. 44p (VAT £3.54 incl.)**

## New Heathkit VHF Wattmeter

Perfect tune-up tool for 2-metre gear—has built-in SWR bridge. 50 to 160 MHz range—covers 2-way commercial, aircraft and ham communications.

**Kit K/HM-2102 £19.80 Carr. 44p (VAT £1.84 incl.)**

## Heathkit Regulated A.C. Power Supply

**Kit K/HWA-202-1 £15.40 Carr. 44p (VAT £1.44 incl.)**

## Heathkit Tone Burst Encoder

**Kit K/HWA-202-2 £12.10 Carr. 44p (VAT £1.14 incl.)**



**HM-2102**

## FREE HEATHKIT CATALOGUE

Contains something for everyone: Hi-Fi Stereo, Testers & Instruments, SWL, Metal Detectors, even a Battery charger Kit. Mail the coupon... Today!

Heath (Gloucester) Limited,  
Gloucester GL2 6EE.

Please send me the FREE Heathkit catalogue

Name \_\_\_\_\_

Address \_\_\_\_\_

Heath (Gloucester) Limited  
Department SW/07/73  
Gloucester GL2 6EE  
Telephone 0452 29451

**HEATH**  
**Schlumberger**

# Radio Shack Ltd ★

London's Amateur Radio  
Stockists

Just around the corner from West Hampstead Underground Station

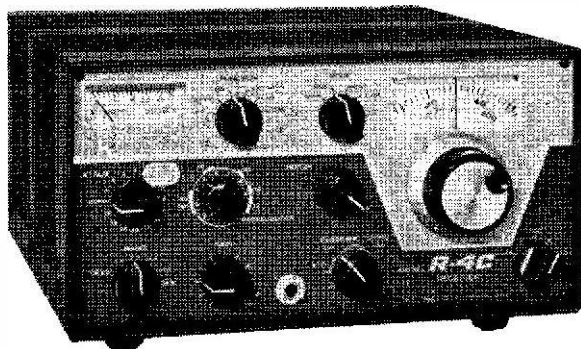

## DRAKE ★ ★ ★ ★ SUPERIOR PERFORMANCE ★

### ★ LONG TERM RELIABILITY ★

### ★ MODEST COST ★

COMPARE QUALITY AND PRICE WITH ANY OTHER EQUIPMENT AND CONFIDENTLY BUY DRAKE

PRICES INCLUDE VAT

#### RECEIVERS and ACCESSORIES

2-C	Receiver—SSB, AM, CW, RTTY ...	£146.30
2-AC	Crystal Calibrator for 2-C ...	£9.35
2-CS	Matching Speaker for 2-C ...	£11.00
2-CQ	Q-Multiplier/Speaker for 2-C ...	£25.30
2-NB	Noise Blanker for 2-C ...	£13.20
R-4C	Receiver—SSB, AM, SW, RTTY ...	£242.00
FILTERS	Bandwidths—250, 500, 1.5, 6-0 kHz for R-4C ...	£24.75
4-NB	Noise Blanker for R-4C ...	£31.35
MS-4	Matching Speaker for R-4C ...	£11.00
SW-4A	Receiver—AM, International SW	£165.00
AL-4	Loop Antenna for SW-4, SPR-4 ...	£14.85
SPR-4	Receiver—General Purpose	£286.00
	Amateur Band Crystal Kit for SPR-4 ...	£13.20
5-NB	Noise Blanker for SPR-4 ...	£31.35
SCC-4	100 kHz Calibrator for SPR-4 ...	£9.35
TA-4	Transceive Adaptor for SPR-4/T-4XC ...	£13.20
DC	Power Cord for SPR-4 ...	£2.42
DSR-I	Digital Receiver ...	£1,133.00

#### TRANSCIVERS and ACCESSORIES

TR-4C	SSB Transceiver ...	£297.00
34-PNB	Plug-in Noise Blanker for TR-4C	£31.35
AC-4	115/240v. Power Supply for TR-4C, T-4XC ...	£49.50
DC-4	12v. Power Supply for TR-4C, T-4XC and Receiver ...	£60.50

Carriage extra on all items

MMK-3	Mobile Mounting Kit for TR-4C ...	£3.30
RV-4C	Remote V.F.O. for TR-4C ...	£52.80
FF-I	Crystal Control for TR-4C ...	£24.20
MC-4	Mobile Console ...	£33.00

#### TRANSMITTERS and ACCESSORIES

T-4XC	SSB Transmitter (see AC-4 above)	£256.30
L-4B	Linear Amplifier (includes Power Supply) ...	£396.00
MN-4	Antenna Match Network for T-4XC, TR-4C ...	£49.50
MN-2000	Antenna Match Network—2000 watts ...	£93.50
W-4	RF Wattmeter. 2-30 MHz ...	£29.70
WV-4	RF Wattmeter. 20-200 MHz ...	£35.20
C-4	Station Control Console ...	£195.80
739 SRD	Cardioid Microphone ...	£9.90

#### ADDITIONAL ACCESSORIES

TV-1000LP	Low Pass Filter ...	£9.35
CA-1	Stacking Cabinet Adaptor for T-4XC, R-4C Crystals for 2-C, R-4C, SW-4A, T-4XC, SPR-4 ...	£2.75
	Fixed Frequency Crystals ...	£3.85
	Spare Operating Manuals (Small) ...	£1.65
	Spare Operating Manuals—TR-4C, R-4C, T-4XC, 2-C, C-4 ...	£2.20
	Spare DSR-1 Operating Manuals	£9.90

ALL PRICES INCLUDE VAT

DRAKE — SALES — SERVICE

SECURICOR ★ COURIER EXPRESS ★ B.R.S. ★ ACCESS ★ BARCLAYCARD ★ UDT

## RADIO SHACK LTD.

188 BROADHURST GARDENS  
LONDON, NW6 3AY

Just around the corner from West Hampstead Underground Station

Telephone: 01-624 7174 Cables: Radio Shack, London, N.W.6.  
Giro Account No.: 588 7151

OPEN 6 DAYS 9-5 CLOSED 1-2 p.m.

## AMAZING PRICE BREAKTHROUGH BARLOW-WADLEY XCR-30 M.K.2. RECEIVER.

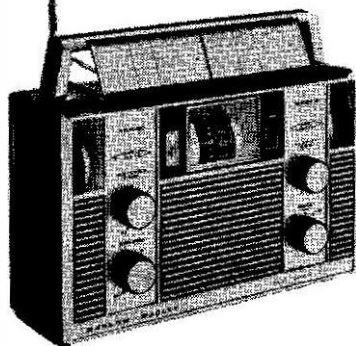

A COMPLETELY NEW CONCEPT IN PORTABLE RADIO DESIGN

1. 0.5 to 30 MHz continuous coverage—direct readout.
2. Antenna tuning for maximum sensitivity.
3. AM, CW, SSB (selectable USB and LSB).
4. Self powered by six SP2 batteries.
5. Power jack for external 6-12v. D.C. supply.
6. Headphone jack
7. Drift free reception.

NOW ONLY **£79.75**. Insured delivery 75p

TR801 FM TUNER, **£13.75**. Insured delivery 25p

All prices include VAT

Sole Distributors:

**RADIO SHACK LTD.** 188 BROADHURST GARDENS  
LONDON, NW6 3AY

Open 6 days 9 a.m. until 5 p.m.

Closed for lunch 1 p.m. until 2 p.m.

Just around the corner from West Hampstead Underground Station  
Telephone: 01-624 7174 Cables: Radio Shack, London, N.W.6.  
Giro Account No.: 588 7151

## ECHELFORD COMMUNICATIONS LTD.

11 BROADWAY, KINGSTON ROAD, STAINES, MIDDLESEX.

TELEPHONE NOS. STAINES 54401/51176

MAURICE STANSFIELD (G8DNM), RAY BOWDEN

and the rest of the Staff here are available from 9 a.m.—6 p.m. every day except Thursday, when the hours are 9—1 p.m., and Sunday, when we are closed all day. Your queries regarding your radio and electronic requirements either by mail, telephone, or a personal visit will receive most careful attention and what we may not have actually in stock can usually easily be obtained. We are now in close contact with most suppliers of equipment and maintain constant stocks of the following:

**TRIO** — Receivers  
Transmitters  
Test Gear

**J BEAM** — VHF/UHF Aerials  
Mast clamps and  
accessories  
Stolle Rotators

**Sentinel Converters  
and Pre-Amps**

**K.W. ELECTRONICS**  
Range of equipment

### MICROWAVE MODULES

2 metres, 4 metres, 70 cm. converters  
2 metre AM Transmitters  
2 metre AM Receivers  
432 MHz Varactors  
The NEW 2 meter Preamp

Eagle, TTC, Jacksons, Chassis, Diecast and Aluminium Boxes, PLUS large stocks of used and reconditioned Transmitters and Receivers.

EASY CREDIT TERMS AND PART EXCHANGE TRANSACTIONS ARE EASILY ARRANGED

We are attending the following rallies:

Ipswich, 22nd July; Woburn, 5th August; Derby, 12th August.

MEMBERS OF THE AMATEUR RADIO RETAILERS ASSOCIATION

# Western Electronics (UK) Ltd

TOTTON  
SOUTHAMPTON



**YAESU MUSEN U.K. MAIN DISTRIBUTOR**

**YAESU'S NEW WINNER! FT-501**

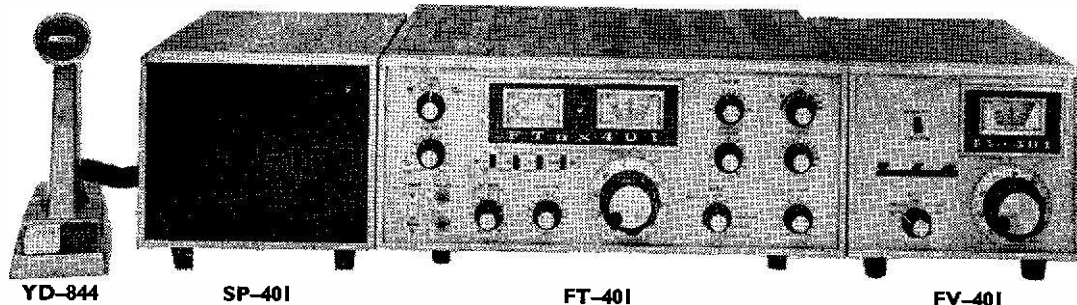

### FT-501

Come and try it at Totton! We DO have a demonstration model. We have a demonstration unit in stock and a consignment arrives on June 13th at Southampton Docks and should be at Totton about 7-14 days later. However, we cannot guarantee that there will be any remaining unsold but at least we'll give you an honest delivery date.

### FR50B Receiver

10-80m. SSB/AM/CW Receiver with 1 kHz Readout and crystal calibrator. The receiver sensitivity is equal to units costing three times the price.

### FT-401

The "401" is becoming increasingly popular and justifiably so. We respectfully draw your attention to the excellent R.S.G.B. Test Review in April, 1973 "Radio Communication" and our own full test report in that issue. The "401" covers 80-10m. at 560w. p.e.p. input on SSB, 430w. DC i/p on CW. The unit is fitted with blower, CW Filter and VOX as standard; no extras to buy.

### FT-101 Mk. 1 SPECIAL OFFER

We still have stocks of this unit. Some people prefer it to the Mk. 2 and at £229 (+ £22.90 VAT) there is certainly no better buy so don't delay in snapping up one of these at the special offer price.

### FL50B Transmitter SSB/CW

A 50w. p.e.p. 10-80m. transmitter fitted with VOX which will work VXO control by itself or transceive with the FR50. Alternatively full VFO coverage is available with the FV50B remote VFO.

### FT-101 Mk. 2 160-10m.

You'll find the "101" in use in just about every country in the world. It bears the hallmark of Yaesu as regards superb quality of craftsmanship and performance. Naturally, we offer it EX-STOCK and with the after-sales service that one expects from us as main distributor.

### FT-75

If your requirement is for a highly compact transceiver of merely good value then this unit gives 12v. DC operation with the DC-75 or AC operation with the FP-75. Buy at pre-Yen re-valuation prices whilst stocks last.

### FT-2FB

10w. output on 144 MHz FM. Crystals fitted on 3 channels complete with microphone, mounting brackets and 12v. DC power lead fitted with a plug to fit the cigarette lighter in your car. Alternatively use it on 234v. AC with the base station FP2AC AC supply which can have n/cad batteries fitted as an extra to enable operation to continue when the mains fail or go on strike.

## YAESU PRICES (Carriage free by Securicor) add 10% VAT

### HF TRANSCEIVERS

FT-75	£99.00
FP-75	£22.50
DC-75	£22.50
FT-101 Mk. 1	£229.00
FT-101 Mk. 2	£280.00
FT/FP200	£190.00
FT-401	£265.00
FT-501	£335.00

### VHF TRANSCEIVERS

FT-2FB	£98.00
FP-2AC p.s.u.	£27.00
FP-ACB + Batts.	£39.00
FT-2AUTO	£157.00
HF RECEIVERS	
FR50 + Cal.	£69.00
FR400DX	£135.00
FR400SDX	£175.00

### HF TRANSMITTERS

FL50 + vox	£79.00
FL400	£160.00
REMOTE VFO	
FV50 for FT75/FL50	£28.00
FV-101	£42.00
FV-401	£42.00
FREQUENCY COUNTERS	
YC-355 30 MHz AC p.s.u.	£97.00
YC-355 220 MHz AC/DC p.s.u.	£120.00

### SPEAKERS

SP101, 400, 401	£11.00
SP101P Phone Patch	£26.00

### LINEAR AMPLIFIERS

FL2000B 1200w.	£165.00
FL2100 1200w.	£165.00
FL2500 2kW.	£130.00



# Western Electronics (UK) Ltd

TOTTON  
SOUTHAMPTON

## ADVANCE INFORMATION

- 144 MHz** FM and SSB TRANSCEIVER. YAESU's FT-220 is the answer. This has full VFO coverage, 144-146 MHz in 4 500 kHz bands + 3 xtal channels. Power is 10w. output, Dial readout is to 1 kHz. With this unit you can work all the FM and SSB boys! Price is not fixed by Yaesu but our "guesstimate" is £150-200.
- 432 MHz** We are pleased to be the first to introduce a 432 MHz 10w. FM Transceiver. No doubt our lead will be followed by others shortly but our aim is to provide a high quality unit with good after sales service. Watch our ads!
- Satellite Tracking** To further cater for the VHF/UHF men we are introducing a new satellite tracking rotator, the only one in the world we believe! It will adjust the angle of elevation to 45°.
- Telescopic Aluminium Masts** In a few months we will have the answer to your prayers for a short mast to go in the car for holiday or portable work or tall masts up to 70' (. . . and the above are just a few of the new items in our comprehensive service!)

**144 MHz LINER 2 SSB 24 channel Transceiver (Ex Stock) £135 VAT £13.5**

## NEW/USED EQUIPMENT (3 months guarantee. Delivery £1 by Securicor)

	Price	VAT		Price	VAT		Price	VAT
Collins 7551, v. good	£170	£17.00	Racal MA79G Drive Unit	£485	£48.00	Trio T5510, remote VFO	£20	£2.00
Eddystone 880A	£58	£5.80	Sommerkamp FT-100 + 160m. good	£150	£15.00	Trio 9R39D5, excellent	£45	£4.50
Hallifacres HT32B Tx. 10-80m. good	£80	£8.00	Sommerkamp FL200B Trans 10-80m.	£79	£7.90	Yaesu FR50B as new	£55	£5.50
Heath SB303 New Assembled + CW	£38	No VAT	Sommerkamp FL200B Trans 10-80m.	£120	£12.00	Yaesu FR50B, as new	£55	£5.50
KW 204, v. good	£100	£10.00	inoue IC790 T & R	£120	£12.00	Yaesu DC200 PSU, unused	£38	£3.80
KW 2000A + AC PSU, v. good	£149	£14.90	Sommerkamp FT-500, mint	£160	£16.00	Yaesu FV400S, remote VFO for FT-400/500, etc., mint	£30	£3.00
KW2000A + AC PSU, v. good	£149	£14.90	Trisao 105fc Teles. tower	£225	£22.50	Yaesu FT-101, mint	£199	£19.90
KW Atlanta NEW, reduced to	£199	£19.90	Trio JRS005E	£45	£4.50	Yaesu FT-101, mint	£199	£19.90
KW Atlanta, used v. good	£145	£14.50	Trio JRS005E	£45	£4.50	Yaesu FT-101, mint	£199	£19.90
KW Ypsa Mk. 2 v. good	£89	£8.90	Trio JRS005E	£45	£4.50	Yaesu FT-200, 2 weeks old!	£175	£17.50
National NCX5, Excellent	£170	£17.00	Trio T5510, mint	£130	£13.00	Yaesu FV-200 VFO	£32	£3.20
National NCX500, excellent	£185	£18.50	Trio T5510, mint	£130	£13.00			

## ROTATORS. All Ex-Stock

AR20	£20	AR22R	£25	TR44	£45	HAM-M	£70	HY-GAIN 400	£115
------	-----	-------	-----	------	-----	-------	-----	-------------	------

## BANTEX FIBREGLASS MOBILE ANTENNAS (Carr. 50p) including base (Ex-Stock) + VAT

70' 1/2, 70 MHz, 1/2 wave	£3.00	BGA, 144 MHz, 1/2 wave	£6.15	Magnetic mount	£6.15	Note. Deduct 50p from price of aerial if base is not required.
144' 1/2, 144 MHz, 1/2 wave	£2.85	B5, 144 MHz, 1/2 wave	£4.35	All aerials complete with base.		

## G WHIPS (Carr. 50p Coils, 20p) THE FINEST MOBILES (Ex-Stock) + VAT

Tribander 10, 15, 20m.	£9.45	LF160 160m. coil	£7.50	160 Ranger	£7.40	80m. coil	£4.00
LF40 40m. coil	£4.00	Whip for LF coils	£1.00	Multimobile 71' 10, 15, 20m.	£12.50	160m. coil	£4.00
LF80 80m. coil	£4.00	160/90m. Duobander	£9.00	40m. coil	£4.00	Basemount for all coils	£1.45
Extendard	£4.75	Flexiwhip 10m.	£8.60	Flexiwhip Coils	£4.25		

## GEM-QUAD. The best FIBREGLASS 10-15-20m. QUAD + VAT

2 ele.	£74.50	3 ele.	£109.80	4 ele.	£144.00	Conversion kits ex-stock.
--------	--------	--------	---------	--------	---------	---------------------------

## J BEAM ANTENNAS. Most types (Ex-Stock)

### MOSLEY (Carr. pd.) (Ex-Stock) from us for fast delivery + VAT

Mustang, 10-20m, 3 ele.	TA33 Jnr., 10-20m.	TA32 Jnr. 'E' or '2'	SWL Listeners dipole	£12.50
2kVY	3 ele.	mast		
TA33 Jnr. 'E' or '2' mast	£45.50	£36.50		
	£37.00	£29.00		
		TA31 Jnr. Rotary dipole		£17.00

### HY-GAIN (Carr. pd.) + VAT

Hy tower, 10-80m. (self-up)	£110.00	LC80Q, 8mm. coil for 14	TH3 Jnr., 10-20m. 3 ele.	203BA, 20m. 3 ele. beam	£72.00
18V, 10-80m. vertical	£12.85	AVQ	600W.	153BA, 15m. 3 ele. beam	£36.50
12AVQ, 10-20m. vert.	£16.50	TH60XX, 10-20m. 6 ele.	£51.50	103BA, 10m. 3 ele. beam	£28.50
14AVT, 10-40m. vert.	£24.50	beam	Hy-Quad, 10-20m. 2 ele.	LAI Lightning arrester	£14.50
18AVT, 10-80m. vert.	£35.50	TH3MK3, 10-20m. 3 ele.	DB10-15 10-15m. 3 ele.	LA2 Lightning arrester	£2.50
		2kV	£75.00	204BA, 20m. 4 ele. beam	£80.00

## NEWTRONICS HUSTLER MOBILE ANTENNAS inc. VAT

8M1 Bumper mount	£5.00	RM10	£4.97	RM20	£6.12	RM75	£8.12
MO2 Mast	£9.35	RM15	£6.12	RM40	£8.12	Carr. 50p	

## W.E. QUAD 10-20m. "boomless" type. Cast aluminium centre, bamboos, etc. £27 (Carr. pd.)

W.E. Trapped dipoles for 10-80m. All are fitted with resin encapsulated traps and a high quality commercial grade centre assembly with cable strain relief.

Type S 500 watts, £14. Type HP for 1 kw p.e.p., £15.25. Type P with a special copper/terylene braid element for ease of coiling up. Supplied with winding spools and 70' co-ax, £17.50.

# Western Electronics (UK) Ltd

Agents: G3UDR Shipston-on-Stour (0608) 61839  
G3PRR Chesham (02405) 4143

Hours of business: 9-5.30; 9-12.30 (Saturdays)

OSBORNE ROAD TOTTEN SOUTHAMPTON SO44DN  
TELEPHONE: TOTTEN (04216) 4930 or 2785  
CABLES: 'AERIAL', SOUTHAMPTON'



## RADIO AMATEUR HANDBOOK (ARRL 1973)

This HANDBOOK, the most widely used manual of communications theory, design, and construction, contains descriptions of the latest solid-state devices and their application. The construction projects included cover the entire field of Amateur Radio interest. Written in a no-nonsense style, the HANDBOOK appeals to beginners and advanced amateurs alike. This edition contains 700 pages, including index, and nearly 100 new illustrations and drawings. The price remains at **£2.85**, also available in a hard-covered clothbound edition at **£3.65** (both post free).

Order from

Publications Dept.  
**SHORT WAVE MAGAZINE LTD.**  
55 VICTORIA STREET,  
LONDON, SW1H 0HF

## THE AMATEUR RADIO SHOP 64MH

13 CHAPEL HILL, HUDDERSFIELD,  
Telephone: 20774

(MEMBER OF THE AMATEUR RADIO RETAILERS ASSOCIATION)

Agents for Eddystone, Yaesu, KW, Trio, J Beam, Shure, Tavasu Mobile, S.S.M. Converters, G. Whips, Heakit Barclay Card, Access, etc.

Please ring for information on all new equipment, we have quite a lot in stock and demonstration facilities are available.

**Second-hand**: Due to Rallys (see you at South Shields, Scarborough, and The Anglican Rally) stocks of gear are changing fast, we have usually a good selection and offer money back guarantees.

**2 Metres**: Our 4MH 2 metre Tx and Modulator is now available again after hold up's due to shortage of components. S.a.e. for details. 2 metre 8 MHz xtals in stock at 90p inc. VAT and post are as follows:—8001, 8002, 8006, 8008, 8013, 8021, 8029, 8036, 8046, 8047, 8064, 8071, 8078, 8080, 8090, 9092, 8106, 8108. All are New 10XJ (will fit into wander sockets.)

**Morse Practice Oscillator** with L/S and battery. Fully wired, £1 inc. VAT. Morse Key, 75p inc. VAT. Both post paid.

**Odds and Ends**: SWR Ind TTC, £8.50; Shure Mics.: 444T, £17.50; 444, £15; 201, £6; 401, £7; TTC Hand Mic., £3.90.

**Components**: 5-pin din plugs, 8p each, 80p doz., £6 100; 3-pin din plugs, 7p each, 70p doz., £5 100; 500mA 750 piv recs. 5p each, 50p doz. UHF plugs PL259, 30p each. 2 pin din L/S plugs 5p each, 50p doz., £4 100. All post paid.

WANTED ALL TYPES OF GEAR

S.A.E. for any gen.

CLOSED TUESDAYS, LATE NIGHT THURSDAYS  
73 G4MH, G3NEW

## BERNARD BOOKS

- COIL DESIGN AND CONSTRUCTION MANUAL 35p post paid  
HANDBOOK OF TESTED TRANSISTOR CIRCUITS 45p post paid  
HOW TO MAKE AERIALS FOR T.V. (Band 1 & 3) AND V.H.F. (Band 2) 23p post paid  
HIGH FIDELITY LOUDSPEAKER ENCLOSURES 45p post paid  
RADIO & ELECTRONIC COLOUR CODES & DATA CHART 21p post paid  
RADIO TELEVISION AND ELECTRONICS DATA BOOK 30p post paid  
TRANSISTOR CIRCUITS MANUAL No. 1 21p post paid  
HANDBOOK OF TRANSISTOR EQUIVALENTS & SUBSTITUTES 45p post paid  
HANDBOOK OF RADIO, T.V., & INDUSTRIAL TUBE & VALVE EQUIVALENTS 45p post paid  
SOUND & LOUDSPEAKER MANUAL (No. 8) 56p  
WORLD'S SHORT WAVE MEDIUM & LONG WAVE RADIO STATIONS & FM & TV LISTING 41p post paid

Available from

## SHORT WAVE MAGAZINE

Publications Dept., 55 Victoria Street,  
London, SW1H 0HF 01-222 5341/2

(Counter Service, 9.30-5.15, Mon. to Fri.)  
(Nearest Station: St. James's Park)  
(GIRO A/c. No. 547 6151)

G2CTV

G3ZY

## J. & A. TWEEDY (ELECTRONIC SUPPLIES) LTD.

Member Amateur Radio Retailers' Association

**TAVASU MOBILE AERIALS.** Centre loaded with spring based top section. Top band complete, £10.19.

**RESONATORS.** 160m., £3.57; 80m., £3.37; 40m., £3.30; 20m., £3.00; 15m., £3.00. Base with co-ax, £1.58. Spring based top section, £2.15; 30in. chromed base section, £2.53. Postage 22p.

**G WHIP MOBILE AERIALS.** Tribander 20/15/10, £11.55; Duo-bander, £9.90; Ranger (160m.), £8.80; Multimobile 10/15/20, £13.75; Base mounts, £1.58; Additional coils, £4.67 each. Postage 22p.

**OSKER BLOCK SWR/POWER METERS,** £20; Field strength meters incl. xtal earpiece and telescopic aerial, £3.50.

**YAESU FL50B.** Transmitters fitted vox (3 only), £79.20.

**YAESU FR50B.** Receivers fitted wvv + calib. (2 only), £69.30.

**KW — YAESU — CASLON CLOCKS — CDR ROTATORS — MOSLEY HY GAIN SPACEMARK KEYS — HAMGEAR PRESELECTORS, ETC. — J BEAM.**

**USED EQUIPMENT —**

Heathkit DX100U + SB10U. Excellent condition, £66. JR500SE, £53; FLDX400, £120; HW17A + Pre-amp + Halo + D.C. p.s.u. Ideal portable rig, £55; Eddystone EC10 Mk. II + A.C. p.s.u. Mint, £55; EC10 Mk. I + S meter + A.C. p.s.u. Mint, £50; Hammarlund HX50, £83. Eddystone 504, £16.50. All prices include V.A.T.

Open Tuesdays to Saturday 9 a.m. to 5.30 p.m.

HP terms available

Part exchanges

79, CHATSWORTH ROAD,  
CHESTERFIELD S40 2AP

Tel. 4982 (68005 evenings until 8 p.m.)

# AMATEUR ELECTRONICS G3FIK

BIRMINGHAM 021-327 1497 021-327 6313

MEMBER OF THE AMATEUR RADIO RETAILERS ASSOCIATION



This month we show a corner of our demonstration room, this section of our premises being devoted exclusively to the display and demonstration of equipment, where the prospective purchaser may take a comfortable seat and test out the gear of his choice to his heart's content without the slightest question of being pressurised into buying. In other words, you are welcome to operate any equipment on display without obligation or distraction from our sales counter which is well removed.

Whilst we carry large and ever-changing stocks of used equipment, please don't forget that we also have a first-class range of new gear by SOMMERKAMP/YAESU, TRIO, KW ELECTRONICS and other leading manufacturers of equipments, aerials and accessories. This includes the SOMMERKAMP range of 2 metre FM gear and we shall shortly have stocks of 2 metre SSB equipment.

PLEASE NOTE: All prices shown include carriage but not VAT

- RACAL RA17 RECEIVER.** Excellent condition and complete with case ... £250-00
- HAMMARLUND SP-600JX RECEIVER.** Very good condition ... £100-00
- HAMMARLUND SP-600JX RECEIVER.** Exceptionally good ... £110-00
- HAMMARLUND HX-500 TRANSMITTER.** The finest TX ever produced by this famous American company, SSB, AM, FM and FSK. 10 thru to 80 180w. pep ... £110-00
- TRIO TS-510/PS-510 TRANSCEIVER** with extra VFO-5. Superb ... £160-00
- TRIO TS-500/PS-500 TRANSCEIVER.** Superficial marks only ... £117-50
- TRIO JR-310 RECEIVER.** Absolutely as new ... £66-50
- YAESU FR50B RECEIVER.** Indistinguishable from new ... £55-00
- YAESU FR50 RECEIVER.** As above but with cal. etc. ... £60-00
- EDDYSTONE EA12 RECEIVER.** Absolutely immaculate complete with speaker/plinth ... £150-00
- EDDYSTONE EC10 MARK II RECEIVER,** with mains PSU. Immaculate. ... £69-00
- EDDYSTONE 888A. RECEIVER.** Excellent condition throughout ... £67-50
- EDDYSTONE 770R RECEIVER.** In superb condition ... £120-00
- SOMMERKAMP FL2000B LINEAR.** Very good condition indeed ... £117-50
- KW VESPA MARK I TRANSMITTER.** Very clean condition ... £81-50
- EDDYSTONE 840C RECEIVER.** Good performance, soiled case ... £45-00
- EDDYSTONE 840C RECEIVER.** Excellent unmarked condition ... £50-00
- KW 600 LINEAR.** A nice piece of equipment in all respects ... £75-00
- TRIO 9R59DE RECEIVERS.** We have a good selection of these from ... £30-00
- TRIO 9R59DS RECEIVERS.** This month we have several in stock, all in mint condition and original packing at ... £41-00
- KW 201 RECEIVER.** Nice condition, good performance ... £83-00
- EDDYSTONE 730/4 GENERAL COVERAGE RECEIVERS.** As advertised last month, fuller details on receipt of your s.a.e. ... £81-50

- Oaker Block SWR200 Power Meters.** The ultimate in SWR/Power Bridges ... £19-25
- TCC SWR Bridges C3042.** Single meter model ... £5-00
- TCC SWR/Power Bridges C3005.** Twin meter model ... £7-85
- Sansel Miniature SWR/Power Meter SE406** ... £3-80
- Medco Filters.** The best on the market, FL50A and FL75A 50 ohm Belling Connectors ... £6-00
- FL50B and FL75B 75 ohm PL259 connectors** ... £6-50
- FH40 High Pass** ... £2-35
- Copal Clocks.** Now down in price. All types ex stock. Illustrated list by return.
- Amphenol PL259 Connectors** ... ea. 30p
- Belling Coaxial Connectors** ... ea. 10p
- 50 ohm Heavy Duty Coax** ... yd. 22p (Carriage extra)

- J. Beam Antennas.** Illustrated catalogue on receipt of S.A.E. Full range in stock.
- G-Whip Antennas** all ex stock. Catalogue by return.
- Shure Microphones** Model 201 Hand ... £5-75 Model 444 Desk ... £13-25
- Mosley Antennas** TA31 Jnr. ... £15-50 TA32 Jnr. E. ... £25-00 TA33 Jnr. E. ... £35-50
- Hy-Gain Antennas** 12-AVQ Vertical ... £16-50 14-AVQ Vertical ... £24-50 18-AVT/VWB Vertical ... £35-50 LC-80Q Loading coil ... £7-50 TH3 Jnr. 3 ele. beam ... £51-50 TH3 Mk. II 3 ele. beam ... £75-00 TH6 DXK 6 ele. beam ... £97-00 BN-86 Balun ... £8-00 Carriage extra on Mosley/Hy-Gain)
- Rotators.** All post paid. Stolle Memomatic 3001 ... £23-40 Stolle Automatic 2010 ... £28-00 CDE AR20 ... £20-40 CDE AR22 ... £25-65 CDE TR44 ... £45-75 CDE Ham-M ... £70-80
- Wightraps** Standard pairs ... £2-90 High Power ... £3-90

An S.A.E. with all enquiries please.

Please don't forget to add 10% VAT on all prices shown. HOME DEMONSTRATION SERVICE! As previously announced this is available on all new gear through our Northern and Southern representatives:—

- Northern:** JOHN ROWLEY, G3KAE, Castle Rise, West Ayton, Scarborough. Tel: West Ayton 3039.
- Southern:** JEFF HARRIS, G3LWM, Cricketfield Lane, Bishops Stortford, Herts. Tel: 0279-56347.

PLEASE NOTE: Our stocks are continually changing and for the very latest used equipment list please let us have your s.a.e.

**ELECTRON HOUSE, 508-514 ALUM ROCK ROAD, BIRMINGHAM, 8.**

# SOLID STATE MODULES

Telephone: 0484 - 23991

63 WOODHEAD ROAD,  
SOLID, LOOKWOOD,  
HUDDERSFIELD, HD4 6ER.

MEMBERS OF THE AMATEUR RADIO RETAILERS ASSOCIATION

**NEW: PA3 DUAL GATE MOSFET PRE-AMPLIFIER**  
We have again been pressed by demand into producing another new module. This is a completely new pre-amplifier, based on the proved performance of our converters. It has been produced with a very small volume (about 1 cubic inch) to fit into the receive aerial lead of transceivers. Its noise figure is the same as our Sentinel converters (2dB) and the gain is 18dB. Supply 9-18v. 5 mA. —ve earth. Supplied with fitting instructions. Price: £5.50.

**OUR EXTREMELY POPULAR SENTINEL FET 2 METRE PRE-AMPLIFIER**  
This amplifier is designed for optimum noise figure and sensitivity and selectivity performance.

- ★ Low noise figure—2 dB.
- ★ High gain—18 dB.
- ★ Supply—nominal 12v, at 5mA, with isolated supply lines. Price: £7.15.

**S.S.M. EUROPA 10 TO 2 METRE SSB TRANSVERTER**  
Firstly, we must apologise to all of you who have had to endure extended deliveries on this item. For components which we use in other equipment to cover the long delivery dates to us. With a new item like the Europa it is obviously impossible to follow this principle and we have found that deliveries quoted have often been extended to two or three times the original quote. However, things are improving and current delivery prices will be supplied on application.

Price: £78.00.  
T.B.C.I. Top Band to Medium Wave Converters. Price: £8.25.  
1CG Crystal controlled calibration Generator. Price: £17.60.  
Magnetic Devices 951, 12 volt change-over relay. Price: £4.12.  
★ Second-hand Equipment—HA350, £60.50; KW Viceroy, Mk. IV, £71.50; FR50B, £60.00.

**SPECIFICATION COVERING THE SENTINEL, SENTINEL X AND SENTINEL M.F. CONVERTERS**

- ★ Noise figure—2 dB. Gain—30 dB.
- ★ Protected dual gate MOSFETS in RF and mixers for excellent overload and cross modulation characteristics.
- ★ All housed in aluminium cases, stove enamelled silver hammer with black trim.
- ★ Every one carefully adjusted for bandwidth and noise figure on our spectrum analyser.

## THE SENTINEL 2 METRE OR 4 METRE OR SATELLITE BAND DUAL GATE MOSFET CONVERTER

By far the most popular converters. Stock IFs for 2 metres — 2.4 MHz, 4.6 MHz, 9-11 MHz, 14-16 MHz, 18-20 MHz, 23-25 MHz, 24-26 MHz, 27.7-29.7 MHz, 28-30 MHz. 4 metre IF: 28-28.7 MHz. Satellite Band IFs: 6-8 MHz, 10-12 MHz, 16-18 MHz, 20-22 MHz, 26-28 MHz. Size: 2½" x 3" x 1½" except the 2.4 MHz, and 4-6 MHz which being double conversion are 2½" x 4" x 1½". Price: £15.12.

## THE SENTINEL X DUAL GATE MOSFET 2 METRE CONVERTER

This 2 metre converter is a de luxe version of our well established Sentinel converter. Contains internal mains power supply but can be used with external batteries. It features an RF gain control to reduce cross modulation and overload of the main receiver. Size: 5" x 1½" front panel, 4" deep. It uses fundamental crystals on the required frequency, i.e. no multiplication. IFs from stock: 27.7-29.7 MHz, 28-30 MHz. Price: £21.45.

## THE SENTINEL M.F. Becoming a very popular unit.

Receives 2 metres on a conventional M.V. B.C. receiver, particularly useful for use with a car radio. IF output 0.5 to 1.5 MHz for (144-145 and 145-146 MHz in two switched bands. "OFF" position switches M.V. aerial straight through to receiver. Double conversion design with two switched crystal oscillators. No frequency multiplication. Size: 5" x 1½" front panel 4" deep. Price: £20.62.

## SM70 70 cms. CONVERTER

- ★ Low noise figure 4.5 dB,
- ★ IF output 144-146 MHz. By using the 70 cm. converter with a 2 metre converter, you can have a high performance 70 cm. unit at a low price, £15.12.

All units advertised, except the Europa at time of going to press, should be ex-stock but you can always ring for confirmation. Call in any time to have a look at the stuff. G3MXG.

All export orders less 10% VAT.

# YOUR MIDLAND STOCKISTS

## INTEGRATED CIRCUITS

7400	18p	7448	£1.35
7401	18p	7473	60p
7402	18p	7474	48p
7404	18p	7475	60p
7413	36p	7490	80p
7420	18p	7492	80p
7430	18p	74121	80p
7440	18p	74141	80p
7441	£1.27	ML709	25p
7442	87p	710 OPA	82p
7447	£1.29	741 OPA	90p

## NUMERICAL INDICATORS

RS num tube (Dec.)	£2.25
Minitron 3015F (7 seg.)	£2.00
Til 209	35p
50 PIV. 3A bridge rect.	40p
14 and 16 Dil Sks (LOW PROFILE)	15p
16 Dil Skt for 3015F	39p
A 7001 Nixi Tube (180v, Dec.)	£1.20
35000K (5V 7SEG) with holder	£1.50

P. and P. 5p on each of above items.

**WE STOCK A COMPREHENSIVE RANGE OF R.S. COMPONENTS, J-BEAM AERIALS AND FITTINGS AND AMTRON KITS.**

## YAESU MUSEN

FT101 transceiver 160-10M	£280.00
FR50B receiver, 80-10M with cal.	£69.00
FT2FB 2M transceiver with tone burst	£98.00

## TRIO

9R-59 DS receiver, -5-30 MHz	£49.50
JR310 receiver, 80-10M	£75.00
SP5D speaker	£4.50
TR7200 2M transceiver	£129.00

## KW

2000E transceiver, 160-10M with A.C. P.S.U.	£265.00
202 receiver, 160-10M	£140.00
Speaker for above	£8.00
204 transmitter, 160-10M	£160.00

## EDDYSTONE

EC10 Mk. II receiver, -5-30 MHz	£86.00
---------------------------------	--------

## TEST EQUIPMENT

Osker power meter	Carr. £18.50, 25p
SWR 200 52/75 Ω	£13.50, 25p
Tech TE-15 GDO .44 280 MHz	£46.00, 29p
KW 107 ATU/SWR meter	£8.25, 25p
KW 101 SWR meter	£12.50, 25p
KW 103 SWR/power meter	£5.25, 25p
Raymart Bandchecker	£5.25, 25p

**CRYSTAL MARKER GENERATOR.**  
FX2000 100K-50 MHz. Will accept FT243/HC6U/HC13U. No crystal supplied £6.00

## TEST METERS

TMK	TP10S	2K/V	£6.77, 21p
	TP5S	20K/V	£8.91, 21p
	500	30K/V	£13.00, 21p
	700B	50K/V	£29.96, 25p
Sanwa	P2B	2K/V	£6.35, 21p
	JP5D	2K/V	£7.62, 21p
	U50DX	20K/V	£10.89, 21p
	A303TRD	20K/V	£14.33, 21p
	380CE	33.3K/V	£20.81, 21p
Tech.	ITI	20K/V	£5.25, 21p
Reace	T-K	1K/V	£2.40, 16p

## BOOKS

"Making a Radio"	15p, 8p
"How to make Walkie Talkies for Licensed Operation"	40p, 16p
"Radio Teach Yourself"	75p, 21p
"Surplus Equipment Manual"	£3.25, 25p
"Pro Fix Maps"	65p, 6p

## NO V.A.T. ON BOOKS

## AERIALS

Bantex fibreglass 2M ½ wave	£4.35	Carriage at cost
Bantex fibreglass 2M ¼ wave	£2.85	at cost
Halsol 160M whip	£7.40	approx.
G whip 160M Ranger	£7.50	£1.00
G whip 160/80M	£9.00	
Low Loss, 75 ohm, 13p yd, P. and P.	25p	
G whip 160M Flexiwhip	£12.25	
G WHIP MULTIMOBILE 71 (10/15/20)	£12.25	
G WHIP TRIBANDER (10/15/20)	£10.50	

PLEASE ADD 10% VAT TO ALL PRICES

**AMATEUR RADIO**  
CHAS. H. YOUNG LTD.

170-172 CORPORATION ST. BIRMINGHAM B4 6UD

NO C.O.D. PLEASE PRINT YOUR ADDRESS. YOU MAY ORDER GOODS BY PHONE AND PAY BY ACCESS OR BARCLAYCARD. SIMPLY QUOTE YOUR CARD NO.  
TEL: 021-236-1635



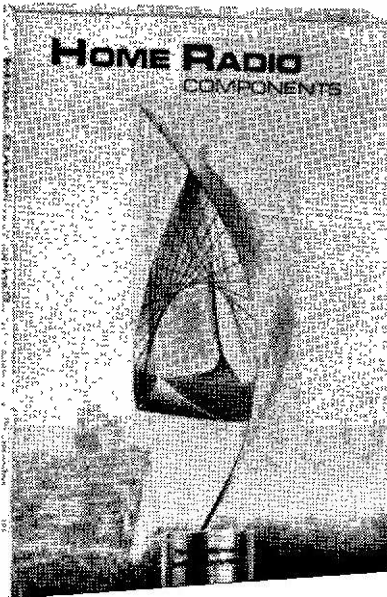

250 pages 11 3/4" x 8 1/2"

Over 6,785 electronic components clearly listed and indexed

1,750 pictures

10 free Vouchers each worth 5p.

Price list regularly updated

Bookmark with useful list of technical abbreviations

# The Catalogue you MUST have!

Details of our popular Credit Account Service and our Easy Ordering System are included in the catalogue.

**Only 55p.**  
plus 22p POST AND PACKING

**POST THIS COUPON**  
with cheque or P.O. for 77p.

The price of 77p applies only to catalogues purchased by customers in the UK and to BFPO addresses.

Please use block capitals



Name .....

Address .....

**HOME RADIO (Components) LTD.** 912966 London  
Dept. SW, 234-240 London Rd, Mitcham, CR43HD

## WE ARE THE ANTENNA PEOPLE

### SOME ANTENNAS

#### MONO-BANDERS

A-310	3 Element.	10 metres	£24.00
A-315	3 Element.	15 metres	£25.00
Classic-203-C	3 Element.	20 metres	£70.00
A-91-S	9 Element.	2 metres	£7.50
D1-10	Ground Plane.	10 metres	£18.00
D1-2	Ground Plane.	2 metres	£6.50
MCA-10	10 metre Quad	...	£45.00
MCA-15	15 metre Quad	...	£45.00
MCA-20	20 metre Quad	...	£48.00

#### DUAL-BANDERS

Elan	3 Elements.	10 and 15 metres	£30.00
Elan	2 Elements.	10 and 15 metres	£22.00
TD-2	Trap Dipole.	40 and 80 metres	£22.50

#### TRI-BANDERS

Mustang	3 Elements.	10, 15 and 20 metres	£44.00
Mustang	2 Elements.	10, 15 and 20 metres	£33.00
TA-33 Jr.	3 Elements.	10, 15 and 20 metres	£35.00
TA-32 Jr.	2 Elements.	10, 15 and 20 metres	£24.50
TA-31 Jr.	Rotary Dipole.	10, 15 and 20 metres	£15.50
Classic-36	6 Elements.	10, 15 and 20 metres	£98.00
Classic-33	3 Elements.	10, 15 and 20 metres	£77.00
V-3 Jr.	Trap Vertical.	10, 15 and 20 metres	£11.00
MCA-3B	Cubical Quad.	10, 15 and 20 metres	£70.00
El-Toro	Vertical.	20, 40 and 80 metres	£11.00

#### QUAD-BANDERS

Atlas	Trap Vertical.	10, 15, 20 and 40 metres	£22.00
-------	----------------	--------------------------	--------

#### SWL Antennas

SWL/7	Dipole.	11, 13, 16, 19, 25, 31 and 49 metres	£11.00
RD-5	Dipole.	10, 15, 20, 40 and 80 metres	£11.00

Note: All "E" Models (2" mast fitting) ... Plus 50p

Note: All prices ex works carriage and insurance extra.

Send for HANDBOOK containing full details of Antennas and other technical information. 25 pages 15p. Refundable upon purchase of Antenna.

# impact

ALL PRICES PLUS V.A.T. 10%

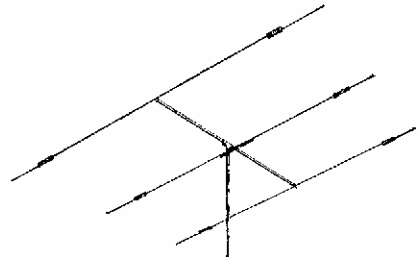

TA 33 Junior

# MOSLEY Electronics Ltd

40 Valley Road, New Costessey, Norwich,  
— ADMINISTRATIVE ADDRESS — NOR 26K, England.

**R. T. & I. ELECTRONICS LTD.**

where equipment is fully overhauled

KW VESPA 2 and p.s.u. ... ..	£105.00 (£3.00)
HEATHKIT GR 64 ... ..	£25.00 (£1.00)
KW/GELOS CONVERTER (into 4.5 MHz) ...	£16.00 (50p)
LAFAYETTE HA350 ... ..	£60.00 (£1.50)
LAFAYETTE HA800 ... ..	£48.00 (£1.00)
HEATHKIT RA1 ... ..	£35.00 (£1.00)
LAFAYETTE HE 80 ... ..	£50.00 (£1.50)
HAMMARLUND SP-600-JX6 ... ..	£135.00 (£2.00)
EDDYSTONE 770U ... ..	£160.00 (£2.00)
HEATHKIT DX 100 Transmitter ... ..	£45.00 (£3.00)
EDDYSTONE EC10 Mk. 2 ... ..	£68.00 (£1.00)
KW 2000A with A.C. p.s.u. ... ..	£180.00 (£3.00)
NATIONAL NCX-5 with A.C. p.s.u. ... ..	£220.00 (£3.00)
TRIO TS 510 with A.C. p.s.u. ... ..	£150.00 (£3.00)
EDDYSTONE 960 Receiver ... ..	£120.00 (£2.00)
KW 201 Receiver ... ..	£90.00 (£2.00)
HEATHKIT RGI Receiver ... ..	£33.00 (£1.50)
TRIO JR-500-SE Receiver ... ..	£58.00 (£1.50)
RCA AR88D Receiver ... ..	£75.00 (£2.00)
TW 160 Communicator 12v. D.C. ... ..	£48.00 (£1.50)

WE CAN ALSO SUPPLY ANY MAKE OF NEW EQUIPMENT—and have pleasure in giving a few examples which are normally in stock:—

**STOCKISTS OF YAESU MUSEN EQUIPMENT.**

**AVOMETERS**, Model 7, Mk. 2, £37.60; Model 8, Mk. 5, £40.90; Model 9, Mk. 4, £40.90; Model 40, Mk. 2, £37.60; Model 72, £18.20; Multimeter, Mk. 4, £13.50; Standard leather carrying case (Models 7, 8, 9, 40), £6.50; Every-Ready dixo, £7.40; Multimeter leather case, £3.30; 10KV D.C. Multiplier for Model 8 or 9, £6.10; 30KV D.C. dixo, £9.90; Pair of Long Reach Safety Clips, £1.50; Models EA113 Electronic, Avo, £82.00. All above post free in U.K. Trade and Educational enquiries invited.

**S. G. BROWN'S HEADPHONES**, Type "F", 120 ohms, 2,000 ohms, 4,000 ohms, £5.90 (25p); Rubber car pads for same, 45p per pair (5p). Type 3C/100 Noise excluding (with superb fitting), high quality, electro dynamic, £7.55 (25p). Standard Jack Plugs, 25p (4p).

**EDDYSTONE EQUIPMENT RECEIVERS**, 8307, £189.00; EC10/2, £86.00; 1000, £210; 1001, £230; 1002, £293; 1004, £280; 924 A.C. mains p.s.u., £7.75 (50p); Double Aerial 731/1, £7.50 (50p); Plinth Speaker, 906, £6.20 (50p); General Purpose Speaker, 935, £5.55 (40p); Edometer, 902 Mk. 2, £29.50 (50p); Telescopic Aerial, LP3126, £2.50 (25p); Die-cast Boxes from 45p (10p). Brochure on request.

**CODAR EQUIPMENT**, CR70A, £27.50 (65p); PR30X, £9.50 (30p); PR40, £8.90 (30p); Leaflets on request.

**LAFAYETTE HA600 Receiver** £50.00 (50p).  
**LAFAYETTE HA800**, £57.50 (50p).

**NOTE:** We request that from April 1st 10% VAT must be added to all prices, new & secondhand, inc. carr. & packing.  
Carriage for England, Scotland and Wales shown in brackets.  
Terms: C.W.O., Approved Monthly Accounts, Hire Purchase and Part Exchange. Special facilities for export.

**At R.T. & I.**

- ★ We have full H.P. facilities.
- ★ Part exchanges are a pleasure.
- ★ We purchase for cash.
- ★ We offer a first-class overhaul service for your electronic equipment, whether you are an amateur or professional user.
- ★ We have EASY Packing facilities.
- ★ We welcome your enquiries for specific items which although not advertised, may very well be in stock.

**FREE SHURE MIC. WITH EVERY KW TRANSMITTER or TRANSCEIVER purchased**

**PARTRIDGE "JOYSTICKS," "New Lightweight VFA" £11.00 (40p).**

**"JOYMATCH" III. Aerial Unit, £11.00 (40p). LO-Z500, £16.00 (40p); ATU kit, £4.50 (30p); ATU assembled, £5.50 (30p); Artificial earth £4.50 (30p); Aerial Bandwidth, £4.50 (30p). Literature on request.**

**TRIO EQUIPMENT. Receivers:** 5R59DS, £49.50 (£1.00); JR 310, £95.00 (£1.00); JR 599, £185.00 (£1.50); **Transmitter** TX-599, £185.00 (£3.00); **Transceiver** TS 515 and PS 515, £210.00 (£3.00); **Loudspeaker** SP5D, £4.50 (50p); **Headphones** HS4 (equivalent), £6.00 (20p); **Stabiliser**, 60p (5p). Leaflets available.

**SHURE MICROPHONES**, 444T, £15.00 (40p); 444, £13.00 (40p); 401A, £6.50 (30p); 201, £5.40 (30p); 202, £6.00 (30p). Full details on request.

**KEYNECTORS**, piano key mains connector units, £2.95 (25p).

**VALVES**. Please state your requirements.

**ADVANCE DMM2 DIGITAL MULTIMETER**, £99.00 (50p), etc., etc  
**TMK METERS:** TMK900, £9.00 (25p); TW20CB, £11.25 (25p); TP55N, £6.25 (25p); 700, £18.00 (25p); also leather cases.

**PHILIPS PM2403 ELECTRONIC MULTIMETER**, £49.00 (25p), etc., etc.

We also supply **PHILIPS and KORTING COLOUR TV TEST EQUIPMENT**, including Colour Bar Generators, Converters, etc.

**KW EQUIPMENT (Don't forget your FREE mic. with every Tx. and Txcr-l).** KW2000B + A.C. p.s.u., £240.00 (£2.00); D.C. p.s.u. for KW2000B, £44.00 (50p); KW 2000B only, £200.00 (£1.50); KW2000E plus A.C. p.s.u., £265.00 (£3.00); KW ATLANTA + A.C. p.s.u., £190.00 (£2.00); Remote V.F.O. for Atlanta, £34.00 (50p); VOX unit for Atlanta, £7.50 (25p); Remote V.F.O. for 2000B, £36.00 (50p); KW1000 Linear amplifier, £135.00 (£1.50); KW202 Receiver with calibrator, £140.00 (£1.50); KW 202 Matching speaker, £8.00 (80p); KW204 Transmitter, £160.00 (£2.00); KW107 combined E-Z Match; VSWR indicator, dummy load, and ant. switch (4 outlets) 52 or 75 ohms, £46.00 (50p); KW103, VSWR and power meter, 52 ohms, £12.50 (45p); KW101, VSWR meter, 52 and 75 ohms, £8.25 (30p); also E-Z match, dummy load, trap dipoles etc., etc. Details on request.

**R. T. & I. ELECTRONICS LTD.**

Ashville Old Hall, Ashville Road, London, E11 4DX Tel: 01-539 4986

**THOUGHTS ON RECEPTION . . . . .**

Whatever receiver you have, whether an expensive or inexpensive one, an old one, homebrew or surplus there comes a time when you think it could do better with the DX. This is when you consider more front end gain such as can be provided by a preselector, not just any preselector but possibly one that also boasts an antenna tuner. This does two jobs in one go, gets the R.F. into the receiver in an efficient way and gives it a boost as well.

We can supply such a preselector, in fact we have four models to choose from, solid state or valve over a considerable price range. These units used properly with their gain turned up and your receiver's R.F. gain control turned down as far as possible will bring up the signal to noise ratio of almost any receiver.

Used like this we think that control over signal to noise ratio is left entirely to the pre-selector, with your receiver's R.F. stage acting as a tuned buffer giving very little gain on its own account. The preselector with its antenna tuner and gain doing a better job of getting the R.F. into your receiver than the receiver on its own. Under these conditions cross modulation should be no worse than the receiver and signal to noise ratio a lot better. Also image rejection will be improved on receivers with low I.F.'s.

As this is our 10th year of producing almost entirely preselectors it is just possible that we speak from experience in this field, try us and see.

We can also supply you with a calibrator for those receivers lacking this refinement but that's another story. Why not send for our illustrated leaflets on all our units, tell us the type of receiver that you have and perhaps we can advise you better.

**HAMGEAR ELECTRONICS**

2 CROMWELL ROAD, SPROWSTON, NORWICH, NOR 65R.

(OFFICE ONLY)



# THE KW 204 transmitter

## excellent value & performance

Includes the following features:

- 10-160 metres—180 watt pep—SSB/AM/CW.
- Reliable 6146's in PA.
- Beautiful CW keying characteristic.
- 10metre coverage 28.0—30.0 MHz.
- Built-in power supply.
- Good audio "punch" on SSB.
- Smooth 2-speed slow-motion drive.
- KW after sales service and spares.

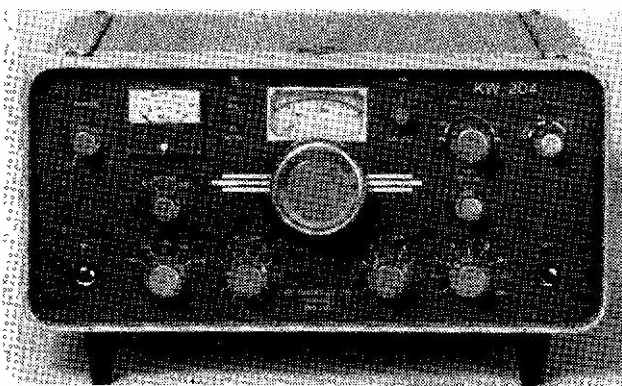

Price  
**£160.00**  
plus  
V.A.T.  
(carriage  
Extra)

Send for catalogue which includes: MATCHING RECEIVER KW202 (another winner)

with the KW "Q" Multiplier built-in (which many cw operators prefer to a narrow filter). MATCHING KW1000 LINEAR AMPLIFIER, MATCHING KW107 SUPERMATCH, MATCHING KW108 MONITORSCOPE. Also—KW101 SWR METER, KW103 SWR/RF POWER METER, KW DUMMY LOAD, KW TRAP DIPOLES, KW LOW PASS FILTERS, KW ANTENNA SWITCH—Beams, Baluns, etc. **Coming shortly**—KW160 metre, AERIAL TUNING UNIT.

1 HEATH STREET, DARTFORD, KENT Tel: Dartford 25574/21919 Cables: Kaydublew Dartford



All Equipment available through accredited Agents

**EASY TERMS ON EQUIPMENT AVAILABLE OVER 12, 18 OR 24 MONTHS**

## WATERS ELECTRONICS

SOLE DISTRIBUTORS FOR AN EXCITING NEW RANGE OF PRODUCTS

NO GARDEN IS TOO SMALL!

- \* Element length 11ft.
- \* Turning radius 6ft.
- \* 6-10-15-20 metres
- \* 1.5 kW rating
- \* No traps to burn out

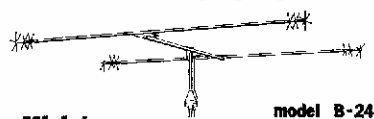

model B-24

**Miniature Band, 2 Element BEAM Antenna**

£35.75 inc. VAT plus £1.50 carr.

By MINI-PRODUCTS INC. USA

DON'T DELAY SEND S.A.E. FOR DETAILS TODAY

### ★ NEW PUBLICATION ★

Interested in GRP? We have been asked to represent the "MILLI-WATT" in the UK. This enthralling USA journal is devoted entirely to low power operation and includes news, technical articles, equipment reports, constructional projects and dx tables. Now in its fourth year of publication it is published six times a year. Subscription payable to Waters Electronics for first class post direct from U.S.A. £1.60 per annum.

### ★ NEW MAGNUM 6 RF SPEECH PROCESSOR ★

Made by Communication Technology Group USA this unit will provide up to 400% increase in talk power without increasing your tvf problem. Rf processing is acknowledged as being the only real way of gaining a true 6dB increase and avoids the problem of distortion experienced with processors installed in the audio chain. A complete range of models is available for Collins, Heath, Yaesu, Trio and Drake. Each unit is fitted with an identical filter to that supplied by the manufacturer of the transmitter or transceiver with which it is used and finished in matching colours. Installation takes about 30 minutes and involves absolutely no butchering of the original circuitry. All connecting cables and hardware is provided. Let us quote for the model suitable for your equipment. These units are not cheap but they happen to be the best. See QST review November 1972.

**EXPORT SERVICE.** We are European agents for all the products we handle and export regularly to most countries. We can quote competitive rates and invite overseas readers to take advantage of our service. No complicated form filling. We deliver the goods direct to you upon receipt or order.

Callers by appointment

Presenting the GOTHAM range of antennas

**A QUAD (10-15-20 metres) FOR £32 !! (including VAT)**

Yes it's true. Our prices for this range of full size antennas have rocked the market. We have now taken our first delivery of these antennas and they are going fast. Also in this range is the V160 which is a 23ft. vertical covering 160 metres to 10 metres at only £16.50. We also have a few full size 3 element beams for 20 metres. The price £60 or £70? No, just £30! At these prices we think you will agree that you cannot afford to ignore the Gotham range.

ACT NOW

### ★ SHORT WAVE LISTENERS ★

We are always happy to advise short wave listeners on their needs. If you are thinking of purchasing an antenna or a new receiver drop us a line for the attention of G3DJV for completely unbiased advice. As a licensed amateur who can still remember his short wave listener days he will be happy to give you friendly advice that could save you expensive mistakes. On the same subject we are now stocking the Trio 9R59DE receiver for £49 plus VAT. Probably the most popular receiver for the beginner and a good standby receiver for the licensed amateur.

**VHF MOBILE WHIPS.** Here is a superb range of professional antennas for the mobile operator. Quite honestly for value for money and performance they leave the rest standing.

- 2 metre quarter wave £2.20 (20p)
- 4 metre quarter wave £3.30 (50p)
- 2 metre 5/8th wave £13.20 (50p)
- No hole boom mount £2.75 (20p)

### ACCESSORY BARGAINS

- ★ TVI? HPIA high pass filter for UHF tv receivers, £1.32 (6p).
- ★ W2AU Balun. 2 kW centre insulator/balun/lightning arrester, £8.25 (20p).
- ★ Wightraps. High power models only £3.68 a pair.
- ★ 1 1/2" Ferrite Rings. For tvf or audio breakthrough, 20p each.

ALL PRICES INCLUDE VAT

**8, GAY BOWERS, HOCKLEY, ESSEX.**  
CALLERS BY APPOINTMENT  
EVENINGS TEL. 03 704 4930





# ABOVE ALL

IT'S THE ANTENNA THAT COUNTS!

**A PARTRIDGE PACKAGE COMES COMPLETE WITH THE VITAL WORLD RECORD JOYSTICK V.F.A.**

Phone us with your ACCESS/BARCLAYCARD Info.  
**WE DO THE REST! (Tel. 0843 62535)**

The Space Age WORLD RECORD award winning 7' 6" long All Band JOYSTICK VFA Antenna—JOYMATCH A.T.U.—TRIO RECEIVER or TRANSCEIVER—Matching HEADPHONES—A COMPLETE STATION IN ONE COMPACT PACKAGE—THE FLAT DWELLER'S DREAM!

JOYSTICK VFA £12.54 (A); JOYMATCH ATU 111  
★ or 111A £12.54 (B); JOYMATCH ATU LO-Z500  
£18.04 (C);

**COMMUNICATIONS 8Ω HEADPHONES £2.86 (D)**

(All including V.A.T. carriage, packing, accessories and insurance.)

**PARTRIDGE PACKAGE No. 1**  
9R59DS receiver . . . £34.45  
\*Items (A); (B); (D) above £12.10  
Complete Gen. Coverage  
Station . . . £66.55

**PARTRIDGE PACKAGE No. 3**  
JR599 receiver . . . £176.00  
\*Items (A); (B); (D) above FREE  
Complete Amateur  
RX Station . . . £176.00

**PARTRIDGE PACKAGE No. 2**  
JR310 receiver . . . £82.50  
\*Items (A); (B); (D) above £7.70  
Complete Amateur  
RX Station . . . £90.20

**PARTRIDGE PACKAGE No. 4**  
TS1P5S15 Transceiver  
150W . . . £231.00  
\*Items (A); (C); (D) above FREE  
Complete TX-RX  
Station . . . £231.00

ALSO : SP5D SPKR. £4.95 ; OA2 MAINS STABILISER 74p

**NEW:** World-wide reception on the amazing "DX—CRYSTAL SET" £2.20 including unique aerial.

**NEW:** Partridge are appointed stockists of AMTRON quality kits—Send for fully illustrated Brochure and Price List.

## PARTRIDGE BUDGET LINE—

**ARTIFICIAL EARTH—SOLVES YOUR EARTH PROBLEMS £5.28 ; AERIAL BANDSWITCH—TUNED AERIAL £5.28 ; A.T.U. KIT—FULL COVERAGE TX/RECEIVER £5.28 ; ASSEMBLED £6.38.**

(All including V.A.T., Carriage, Packing, Accessories and Insurance.)

Send 3p stamp for full illustrated details of Partridge Products. TRIO brochures (state which) 3p stamp extra.

**NO V.A.T. ON OVERSEAS ORDERS !**

CARRIAGE & INSURANCE EXTRA OVERSEAS

BOX 4,

**PARTRIDGE**  
BROADSTAIRS NENT ENGLAND  
**ELECTRONIC LTD**

Telephone : 0843 62535 or 62839 cheap periods

## ESSENTIAL BOOKS

**AMATEUR RADIO SSB GUIDE.** A complete guide to the understanding, operating and maintenance of SSB equipment, £1.50, post free.

**HOW TO MAKE WALKIE TALKIES FOR LICENSED OPERATION.** Only 40p, p.p. 10p.

**HANDBOOK OF BASIC ELECTRONIC EQUIPMENT.** Gives specific details of the components and equipment used in Radio, Television, Short-Wave Listening, Amateur Radio, Tape-Recording, Record Playing. Enables you to choose the best components and accessories and use them economically and safely. Illustrated, £1.75, post free

**THE GOVERNMENT SURPLUS WIRELESS EQUIPMENT HANDBOOK.** Gives circuits, data and illustrations plus valuable information for British/U.S.A. receivers, transmitters, trans/receivers. With modifications to sets and test equipment. Latest impression, £3.25 including postage.

**DIRECTORY OF GOVERNMENT SURPLUS WIRELESS EQUIPMENT DEALERS.** Gives details of surplus wireless equipment stores and dealers including addresses plus equipment and spares that they are likely to have available. A valuable book, only 40p, p.p. 10p. Allow 28 days for delivery as directory is being brought up to date.

**RADIO HANDBOOK.** Latest impression. 974 pages. W.I. Orr. 19th edition. A comprehensive communications handbook written especially for the radio amateur and electronics engineer. Covers every aspect of amateur radio, including the latest designs and developments, £7.50, post free.

**COSMIC RADIO WAVES.** Start a new hobby—RADIO ASTRONOMY. This big book of 444 pages is an ideal handbook for the beginner and established enthusiast. Numerous photographs and illustrations. Published by Oxford University Press. Price £2.50, p.p. 25p.

**THE SCATTERING AND DIFFRACTION OF WAVES.** A goldmine of information for the experimenter, amateur and scientist. Profusely illustrated. Published by Oxford University Press. Price £1.60, post free.

**TRANSISTOR SUBSTITUTION HANDBOOK.** Gives the substitutes for thousands of European, American and Japanese transistors. Where no substitute is available shows how to select a replacement. Includes over 10,000 types, £1.40, post free.

**PERSONAL CALLERS WELCOME AT OUR NEW SHOWROOM AND TRADE COUNTER.** Hartleys Yard, off Town Street, Armley, Leeds 12. (Just past the White Horse Inn). The Norths largest selection of Radio and Electronics books plus thousands of books on ALL SUBJECTS at discount prices.

**PROBLEMS IN ELECTRONICS WITH SOLUTIONS.** A must for the student, technician and electronics engineer. Contains 349 problems, answers and how they were arrived at. Includes all aspects of electronics, amplifiers, power supplies, computers, aerials, waveguides, transmission lines. 307 pages. Only 90p, p.p. 10p.

**THE MODERN DICTIONARY OF ELECTRONICS.** Contains concise definitions of more than 18,000 terms in electronics, communications, micro-electrics, fibre optics, semi-conductors, computers, medical electronics. Fully illustrated. Essential to any collection of electronics reference books, £6.50, post free.

**99 WAYS TO IMPROVE YOUR SHORTWAVE LISTENING.** Essential to all SWLs, £1.90, post free.

**A COMPREHENSIVE WORKING HANDBOOK OF SATELLITES AND SPACE VEHICLES.** A handbook that provides important data both tabular and graphical enabling space scientists, technicians and telecommunication engineers to acquire a greater working knowledge of satellite and space vehicle design, launching, orbiting, etc. Includes a detailed coverage of COMMUNICATIONS IN SPACE. An imposing book of 457 pages. Published at £8.20 but last dozen copies available at the trade price of £6.50, post free.

## GERALD MYERS

(SW)

Publisher & Bookseller

All mail orders to:

18, SHAFESBURY STREET,  
LEEDS LS12 3BT

for immediate despatch unless otherwise stated.

# The SHORT-WAVE Magazine

## EDITORIAL

### ***Justification***

We have often enough outlined broadly what might be called the Argument for Amateur Radio in face of the Pressure on Ether Space—it being agreed that the ether, like the air we breathe, is free for all to use, subject to reasonable safeguards.

To deal with some questions so frequently asked when Amateur Radio is under discussion, such as—"What good are amateurs?"—"What do they do?"—"Can they serve any useful purpose? ". The quick answer is, of course, that the mere fact of there being some 18,000 of them in the U.K. alone, and nearly 500,000 in the world of the West as a whole, is by itself a good enough reply to these questions. If no benefits flowed or advantages accrued from the pursuit of Amateur Radio, it could not possibly exist on such a scale—and continue to expand at the rate it does. (In the U.K. 50% in six years).

It is this fundamental interest in and practical knowledge of radionics that make the radio amateur, and the Amateur Radio movement, so important from the national point of view. As a nation, we are among the leaders in the Electronic Age into which the world has moved. Amateur Radio is one of the influences by which radionics engineers and technicians of the best type are produced. This is not an imaginary or high-falutin' conception of the value of Amateur Radio, nor even a theoretical appreciation of its potential usefulness, but is actual fact, proved over and over again. These lines will fall under the eye of some of the leaders, senior engineers and executives, of the radio industry, to say nothing of many "lesser lights" in it—let them ask themselves how much they owe to Amateur Radio, and whether it was not as transmitting amateurs that they got their start!

For its educative influence alone, therefore, the healthy development of Amateur Radio is of the utmost importance to the nation. Those who, as juniors, learn the fundamentals simply because they want to get on the air, go on to take out a licence, and then have ideas of becoming professional, are regarded as being of the very best—provided they progress to getting themselves properly qualified. Amateurs, as amateurs, cannot expect to get far in a professional environment.

And in the larger context, can it be seriously suggested that tens of thousands of radio amateurs, in daily communication with one another all over the world—and to a lesser degree the correspondence, personal contact and mutual interest which such communication entails—do not together contribute anything to the international understanding and co-operation for which the politicians are striving?

*Austin Forsyth  
G6FO*

# COMMUNICATION and DX NEWS

*E. P. Essery, G3KFE*

**H**ELLO, again! As your scribe sits at his typewriter on a fine evening, with birds chattering in the garden and a real June heatwave in progress, it seems almost sacrilege to think of DX, let alone work it. However, let the receiver loose on a DX call sign, and most of us would instantly drop whatever we are doing to take up the chase again.

Since this is the case, let us begin by looking at the most difficult band of them all where real DX is concerned, namely Top Band.

We make a start with W1BB (Winthrop, Mass.) and his invaluable *Bulletin*. Perhaps the first point he makes which is of interest in our context is that he found DX conditions for Top Band very poor indeed, from March 9 right through April and for the first week of May. Stew himself had been stuck fast at 113 countries since June 1972 and then in February added ZD9BM and 4W1AE to his total in one evening! Talking of 4W1AE, John believes that one can find a spot from which one can work DX, and yet not be able even to hear it from somewhere nearby, due to selective skip effects.

An interesting point in W1BB's discourse is the paragraph on loop antennae. It seems that in a noisy QTH, a loop operated into a transistor pre-amp offers some advantages over a bigger aperture aerial,

although of course the half-wave layout is clearly ahead in a quiet location. There are several W's using loops for receiving, among whom one notes W7DOL/G, who has used it for reception while working Europeans—a three-foot diameter job, and a 65-foot loaded vertical for the transmitter managed to work among others GM3YCB, and to hear but not connect with G3YUV. K5CIT/KH6 says that many Europeans don't look up as high as 1997 kHz, where he sits calling his head off. VK6HD suggests that the VK boys use 1825-1830 kHz when wanting U.S. contacts, and 1803 kHz for European QSO's. Talking of Europeans, G3YUV, G3LIQ and G3XAP might be interested to know that their signals have been heard by VK6HD.

Still with the real, intercontinental DX on this band, ELØN/MM writes (both direct and through G3CED) to let us know how his trip is coming along. The Joystick was mounted vertically on the side of the upper bridge deck, fed through about 15ft. of wire and resonated to Top Band with the Joymatch ATU—he was still hearing DHJ when off Western Australia. The FT-101 is not fitted with the CW filter, and this was the prime cause of the loss of the report from EI9J when the ship was at 29° South, 15° East. However, from 6°S, 5°W, LU5EVM was heard and

lost in QSB apparently calling ELØN/MM, and PY1DVG was also hooked. All this goes to show what an enormous difference is made to the propagation both on "send" and "receive" when a vertically polarised aerial is used in conjunction with a near-perfect take-off, despite local noise and QRN problems. His ship is the cruise-liner *Fairstar*, 5MXH.

The first ZS6-VK6HD contact fell to ZS6ZE and VK6HD at 2254z on June 9, peaking at 2300z. John is now really on the DX trail and can be found on Friday and Saturday evenings on 1932 kHz, plus possibly the odd evening in the week if he sits up late for any reason.

Nearer to home, we have a bind from G4BWZ, who uses only AM and CW on Top Band, that he has a feathered phoney friend on Eighty, active enough to net QSL's.

"Grass grows in inverse proportion to DX worked," theorises G2HKU (Sheppey), who adds that it doesn't take genius to guess on whose side the dice is *not* loaded! However, Ted keyed with PAØABM and PAØPN, while SSB contacts were made with GM3UPK, GM3YXU and, again, PAØPN.

## Eighty

In the main, the troops have reverted to their previous attitude of "treat with ignore" as far as

The Sittmar passenger liner "Fairstar" (5MXH) on which G3UOF (ELØN/MM) is an operator. The ship does round-world voyages under luxury conditions for about 1,600 passengers. His personal rig is an FT-101 into a Joystick, with which he has made many good DX contacts, including Top Band.

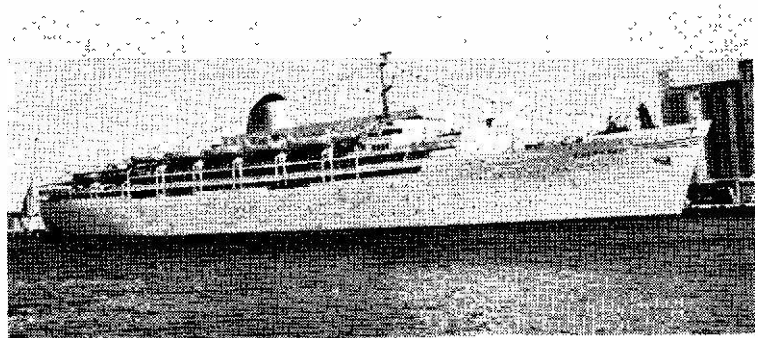

Frank Coldwell, G4ATM, 103 Harrington Avenue, Blackpool, Lancs., FY7 1QD is a professional man and another of those who did not come to Amateur Radio till his late fifties. He took the R.A.E. via Fleetwood Nautical College and then learnt Morse with the assistance of a local all without having had any previous experience of radio. He has a nice station, running K.W. gear with a Hy-Gain 18-AVT outside.



Eighty goes. G8HX (Mansfield) pops up to tell of his adventures with the latest, multi-band, aerial he has been able to twist into his garden shape. Nothing much was worked on Eighty apart from VE1ZZ, and then two hours' solid operating coming from a single CQ, from which no less than nine QSO's resulted. On a more technical aspect, the old DX-100 has had its drift cut down quite considerably by fitting semi-conductors in place of the valve diodes in the low-voltage power supply—the next stage is to repeat the dose on the HV PA line.

Only one contact comes to be mentioned by G3DCS (Ipswich), in the shape of an RTTY clash with PA0OCD. Similar situation at G2HKU, Ted's only one being SSB with 9H1BX.

Eighty for ZS6ZE (Pretoria) meant no U.K. contacts on CW, although VK6HD was worked; on SSB there were Europeans, including G3DDK, KC6SK and ZD9GC on Gough Is. A glance at a globe, or a great-circle map, will show that these QSO's cover vast distances.

#### Forty Metres

A good band being allowed to go to ruin. For ZS6ZE, all was SSB, contacts being made with 4S7AB, KC6SK, KC6JC 5R8BD, 9X5VA, 6W8DY, WB6VGI/VQ9, ZD9GC, JA3JOC and OZ5KF.

CW was the preferred mode for

G2HKU, who used it to work FC0AHY, KP4DJE, KZ5BB, EA9EW, UI8LAC and UG6AW. On SSB, one contact worthy of note was with UI8LAG, at S9 plus and with excellent English.

G8HX has been spreading his wings somewhat since he replaced his 7 MHz aerial with the multi-band array, but he still worked CW with KZ5, and built up his total of DOK's and SPPA districts nicely.

A new correspondent is G4BVS, who divides his report into two parts, from his Amersham home QTH and secondly from Beddgelert in North Wales over the Spring Bank Holiday. The home 14-AVQ gave QRP (five watts to a *Ten-Tec PM3A*) contacts with DA2SO, DL1TA, DL8YU, EA2EY, F6CBM, HB9ANW and YU4ETO, while the /P ground-plane unearthed EI6AK and G13ZAD. It is interesting to note that G4BVS, who is ex-G8GHY, finds himself fascinated by CW operation would that some more of the VHF phone-only fanatics would try it and so expand their interests.

Another holiday-maker was PA6VRZ, who was worked by G2NJ—the PA gave his camp location as Jutberg. G2NJ also found F6WW/M, motoring not far from Caen, Normandy.

Readers may recall that GW4BLE (Newport, Mon.) has been trying for planning permission to put up a tower; Stephen has now

passed the first jump, namely the local authority. It still remains for the Town and Country Planning boys at higher level to put the mockers on the project, but Stephen understands they will be meeting about the time this comes out, and till then has to exercise his soul in patience and hope. However, to pass the time, GW4BLE tackled some contacts, and on Forty offers CN8BO and TU2DO.

#### Comments on This and That

G3DCS says that he has partly offset the difficulty caused by the lack of selectivity of his RTTY filters by separating them from 170 cycles to nearer 400, the object being to reduce the "mark" signal on the space frequency and vice-versa, due to the low selectivity in his filters. On a different tack, Enver reckons 850 Hz shifts are a dead duck in amateur practice, he having only ever encountered a couple on the DX bands; the majority are on 170 Hz shift.

G3ZPF (Dudley) takes issue with your conductor over the latter's comments, last time round, on how to register a protest—David is sincerely, if misguidedly, a believer that protest marches do more good than letters to the *Times*, adducing as evidence the IARU and ITU, the Intruder Watch and, on the other side, all the "things" which wander around our bands. One ha

## BRIEF DX DATA

- A51PN** Try 14085 kHz around 1700. QSL address: H. N. Pradhan, Wireless Communications, Dechentsi, Thimphu, Sikkim.
- KSLTH** Is now on Kure Is. where he will sign KH6HDB /Kure for a period of about one year.
- OHØAM** Aland. June 28-July 3, Martin will be on as OJØAM from *Market Reef*. Going mainly to instal a Tempo-One rig and beam aerial for OHØMA, who is keeper of the Market Reef light-house.
- ZKITA** Tongareva. Operation begins June 29, lasting about 7 days. Look for their SSB on 7083, 7087, 14195, 21295, 28595 kHz and for their CW on any band 10 kHz up from the band-edge.
- VE3RCMP** Royal Canadian Mounted Police centenary. QSL address is Telecommunications Branch, Commissioner RCMP, 1200 Alta Vista Drive, Ottawa, Ontario. Station will be active till the end of August.
- C2...** JA1MCU will be going to Nauru Is., South Pacific before this comes to print. Operation mainly on 40, 80, 160 metres.
- CR8AG, CR8AL** Now the only active stations left in CR8. QSL's for either should go via PY7YS, P.O. Box 34, 6000 Fortaleza, Ceara, Brazil.
- JT...** Look around 14225-14230 kHz for JTØAE, QSL via OK1AIA. Understood UA9VH/JT1 will soon be active on all bands. QSL's to UA9VB. Vic may be able to help with QSL's from other JT's.
- FO8DF** *Tuamotu Archipelago*. Try 14144 kHz around 0515Z. QSL to B.P. 1825, Papeete, Society Islands, South Pacific.

to be a bit careful over this, since most of this interference comes from countries who for one reason or another have effectively refused to accept international law as binding on them. Many of the "intruders" are in fact spurious signals in the particular receiver/aerial set-up hearing them, and a lot of the genuine ones are stations who have lawfully registered objection to the "exclusive" allocation of a particular band to amateurs and have informed the authorities they will be on these frequencies. However, for the pirate BC station, sitting on someone else's channel, with no reference to anyone, no condemnation is too great. To revert to G3KFE's original comment, one knows from experience that the reaction to seeing a gang of demonstrators is to ring up the Police and just ask for them to be removed—about the only people who read their banners are the policemen or the TV viewer. But a letter to the *Times*, or in this case the *IARU News*, is written by responsible people knowing their case will be considered by other responsible people among the readers, who will take the trouble to read right through the argument.

That bit about a longest QSO last time was sure to cause a comment. As your aged scribe thought, 24 hours non-stop for a QSO is a mere bagatelle. G3IDG quotes QST for June 1963, reporting WA2WIR and WA2VFW having a marathon of 99 hours!

SWL Yeoman (Peterborough) writes to say he has a card from 9M2BH, who said he had changed his address. The new one is Lim Phang Choo, 187 Jalan 68, Kepong Baru, Selangor, Malaysia.

G3IDG again, this time on the question of stations in close proximity quotes G3CWZ and G3EYN, who had separate stations in the same room, five feet apart. Why not try something different, like the smallest or largest QSL cards, at the present held by CN8BV and K2SST respectively?

The American National Scout Jamboree, at its two locations, Farragut Park, Idaho, and Moraine State Park, Pennsylvania, will be on the air in August—KJ7BSA, July 28—August 9 from Idaho, and July 30—August 11 from KJ3BSA in Pennsylvania. Look for them

five kHz above the lower limit of the General and Novice sub-bands.

## Ten Metres

Even though we are well into the trough of the sunspot cycle, and in summer conditions, still there comes the odd mention of the band. G3RFG (Henlow) for instance tried Ten often and on the key raised DL7QU, F6KDE, HA8KUX, IØROA, OE5, RB5, UK2, UK3, UF6, UY5, SM4FKK, SP5AD and YU5JHI (not DX but interesting) with heard-ones in the shape of CR6AI, CR7FM, various LU's, PY, YV and 7Q7's, all of which were at levels between S7 and S9. However, far more interesting is the "beacon watch" which Stan has been keeping. He has logged the date and time, and on each occasion has looked for ZC4CY, DLØIGI and 3B8MS, noted their presence and strength, and then scanned the band for other signals. There is a break from May 4 to May 10 and May 12 and 13, *but signals were found on all other days*, either beacon or other signals, or both. The interesting thing is that "when the beacons are audible" seems to bear little relationship to the presence of other signals, either long-range European (which can be accounted for only by non-VHF type propagation) or true DX. The segment of the band checked was in each case 28.0 and 28.2 MHz. Another point is that no cases occurred of propagation beyond what one would assume to be single-hop distances, in an East-West direction (with the possible exception of UA9). However there were quite a few instances of PY, YV and African stations there even when the beacons were not audible! No question of significant effects of the aerial arises, because the ground-plane is essentially all-round in its pattern and appears to conform with theory. (Anyone interested in propagation at 29 MHz could think a lot about these findings. *Editor*.)

ZS6ZE worked a few on the key during NFD weekend, notably DL's, PAO, G3CAR/P, G6LX/P, G3HBR/P, G3LFM/P, G3VCP/P, G3MGP and G4ALE/P, while SSB came up during the month with KC6SK, RL7PCV and a gaggle of JA's.

As for GW4BLE, Stephen offers

Frank Bewley, G8HX, 116 Westfield Lane, Mansfield, Notts., is of course an OT, having been licensed before Hitler's War. His interests are CW on 3.5-21 MHz inclusive, and the aerial is a 136-footer, 35ft. high, contrived into a garden 60ft. long.

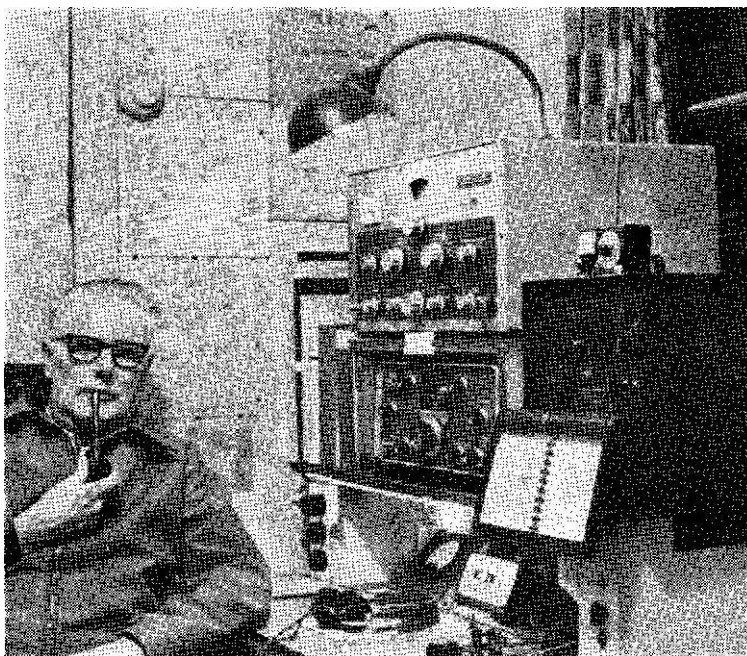

numerous first-hop Europeans, plus the longer hauls into 5B4ES and 5X5NK on Sideband.

#### Fifteen Metres

Nothing like so much in the doldrums as the general level of conditions and the propagation forecasts would lead one to believe.

In the main, G3DNF (Leeds), stuck to his 1½ watts on 21 MHz, and got 4Z4KF, W3WJD and WN4ZVF—the last-named coming up with the fastest-ever QSL card. Short-skip gave the little rig the chance to work loads of Europeans as well. The big rig was not completely neglected, and the bit of extra "steam" came in handy for JY9FOC.

The most pessimistic note is from G8HX, who must have picked the wrong times for he found little of interest audible on the band, let alone workable.

Fifteen for G2NJ (Peterborough) was largely a question of the /MM stations, although Nick did pick off

YU2RMS/X - the /X apparently meaning that the station is being driven by the second op., the first op. being father. (Could be a good pointer to a way of teaching the youngsters how to operate properly, to make 'em spend a probationary period as second op. to a practised OT). Back to the sea, and G2NJ came across JR3KLC/MM, YO4WO/MM, JA7HX/MM and EL0S/MM.

G3DCS eschewed his RTTY in favour of the good old pump-handle, and by this means was enabled to make contact with JA3IL, UA9JH, UA9CAL, UK9AAZ, UA0YT and UF6DX.

For G3ZPF (Dudley) the CW worked sundry Europeans and G3KPT (of QRP fame) whose two watts made the idea of running 150 watts seem a bit silly. However David reacted by going on SSB and in this manner managed to make his presence known with CR7FR, CP6EB, LU7FAG, 9J2DT VS9DX, EA6BZ, EA6BP, 9J2WR, ER3USF, SH3AP, VP2VAM, VQ9DC,

ET3USC, 9Y4EH and ZP5AN.

Only a couple of interesting ones are mentioned by GW4BLE, who offers 3B6CF and 7P8AZ on SSB, both being new countries to him.

ZS6ZE managed to work an assortment of Europeans on both CW and SSB, but also raised KC6SK, KC6JC, KH6DQ, 9X5VA, HS3AIG, ZD9GC, VS6EN, VS6DM, KV4AD and EP2NH on SSB, plus and odd AM contact (the first this column has noted for some long time now) to 5U7BA.

G3RFG as usual stuck to the basic mode, CW, using the FT-DX560 as the prime mover, with the trap vertical. This combination hooked JA1JBB, JA2FDX, JA7XJG, JR1MYZ, K3JH, K4GSS, K7DSZ, KG6AAY, PJ9BN (Bonaire Is.), PY2FFW, PY2GGF, UK9SAY, W1TW, WA2DMK, W3KWH, WB8DMF, W9SNF, WS5MSC (Johnson Space Centre, Houston) and ZS6DE, with the vital element of frustration provided by gotaways CR6OY, HS4AGN, WP4DQL, 9M2CN, and KP4NY.

#### The Workhorse

Yes, we did say *workhorse*, not *workhouse*, even though some of the "communications" are a bit on the weird side. This is, as for so

## Reporting the HF Bands

many years, the band on which to snag that essential new country, even if you later find them on one or other of the remaining DX allocations. The band? Twenty, of course!

Let's first look at what our "specialists" have to say. G3UZ (Goring-by-Sea) had a moment's chuckle when he worked G3TZL/MM, in the South Pacific, he having nearly broken his wrist to no avail to work the same ship ("Sugar Producer") when she was in Barry Docks! (See picture p.667, January) The key, as usual, for contacts with UA0AAB, UW9EY, UK9ACP, UA9WQ, UV9PS, UA9DB, UA9NN, UA9XAC, UV9SN, UA9CBH, UA9AQQ, UA9CAE, UK9WAA, UV9CO, UA9SAA, UK9LAG, UK9AAN, U8IAC, UH9AC, UH8BU, UL7WH, UL7IAN, UL7EAJ, UL7GA, UL7NAD, UK7EAQ, UL7IH, UL7TAA, UG6AG, UD6DFY, UD6DJT, UF6FAX, UF6BD, UF6FAW JA6KD VA3JJ, SV1FR, JX9TM, PY1CBW, PY1DUB, PY1BTC, PY5CFX, VP9BY, 9H1CL, 9H1BZ, 9H1DJ, 9E3USA, PZ1AP, VE3DJU, VE3AHB, HC1EM, VO1CA, 5R8AG, G3TZL/MM and LU2DSB/MM.

An HW-32 at 150 watts p.e.p. and a dipole running N-S is serving G4CCB, and in his first fortnight since changing his G8/3 to G4/3, this New Ollerton station made SSB contact with KP4AWM, PY8ADD, VE1EL, VE1AVW, VO1BT, WA2FUJ, WA2NPP, K3GJD, W3KDD, WA3QJB, WA8NPY, W0NUH, CX1EK/W4, LU1BAR/W3, YV3SZ, YV3TN, YV5HJ and

9Y4MH, which has no doubt given Tony the taste for blood.

That flea-power rig at G4BVS enabled Sean to pound brass with a lot of Europeans from home, including EA4DX, HA0KWLW, 12YBA, IS9FPH, OH0MA, SP's, UB5AAD, UB5NM, UO50BE, UP2PAW, UW6DW and YU1ACN. At the holiday site /P, using the same rig to a vertical, took in mostly the same sort of stuff, but with the addition of F, LA, ON, OK, UA4, and YO3RT. Hardened DX'ers may remark that there is nothing wonderful in these results, but the more thoughtful will think of the invaluable training in CW (or, indeed, phone work) gained by the really low-power operator in the hands of a newcomer learning about DX working the hard way. (To work a UA9 or UA0 with 5 watts or so is quite something. *Editor.*)

G2HKU made CW contacts with WB6CSY, UK0SAL, VK3MJ and W1AW (the ARRL Hq. station) the latter after years of trying. A change of mode to SSB brought him another QSO with 9H1BX.

G3RFG, as we have already seen, spent much more than usual time on Ten with his beacon watch. However, Stan did look around the CW end of Twenty on occasion, which gave him contacts with CT2AO, DU1OR, JA9HQU, K3GJD, KH6IJ, KU9AAN, UK9AAQ, UK9ACP, UK9CCC, VO1AW, W1TW, W7SF, W8HBQ and W9BR; he missed VE8RCS, the latter at "Alert," Ellesmere Is., in Zone 2.

One would have expected that ZS6ZE would have turned in a longish list for Twenty, but it was not so; John offers but KC6SK,

KC6JC and ZD9GC, all on SSB, and no more activity.

GW4BLE found true short-skip conditions on June 7, when he wrote, with inter-G working at S9 plus; earlier in the period Stephen booked in CN8BO, CX1R1, CX8D1, CR3AB, EA6BG, EA6BM, EA6BN, EA6BQ, ZC4DS, 6W8DY, 3B6CF, ZD8KO, SU1MA, 7W3ITU, LU5HF1, PY's, 9K2AU, TG9D1, OH0MAS, 9H1BB, 9H1BX and 9F3USA /P1.

Both CW and SSB were tried by G3ZPF, but David only keyed with Europeans and OY2O was the best of the bunch; however SSB was a little more forthcoming in the way of DX, with VS6GA, SU1MA, YV4AOP, ZS1JP, CI1EO, 9F3USA /P1 (in the Red Sea area), ET3USD, VP9DV, EI8BM, (a real long haul, that one?), GM3A1M/P in Arran (almost as far). GM3TDI, GM3DZB, GM3KCY, and, for a change, YA1ED. In addition, he had the usual collection of W's and Europeans.

Splitting the time between CW and SSB seemed a good thing to G3DCS and so it was. His CW raised W's PY1CBW, VP9HA and various Europeans. With RTTY he extracted copy from I8FJR, UK3DAA, VP2KH and LA1K. Incidentally, G3DCS pleads that CW operators should try to keep clear of 14090-14100 kHz, as this is the bit of the 20m. band where the RTTY addicts foregather to work other enthusiasts; seems that even a weakish CW signal makes mince-meat of RTTY copy.

G2NJ has done so much operating with the QRP lads that he has succumbed to the urge and just



Membership of the party recently operating SV1MA from Mt. Athos, Greece. Left to right, standing, SV1GA, SV1DB, SV1ER, SV1GK, DR5OS, DL1CU, DL8ME, DJ6SI and DL7RT. The arrangements were handled by DL1CU.



G4BKI, Paul Evans, Sunlea, Wheal Speed, Carbis Bay, St. Ives, Cornwall runs an HW-101 and has often been mentioned in this feature. Aged 15, his father is G3DLH and brother G4AMJ. (Another case of "quelle QRM"!.) Paul stands at 166 countries worked and QSL'd but so far holds only 55 cards in confirmation—they will come in.



completed an HW-7 for himself. With it, and an input of just the 2.5 watts, Nick managed a solid contact with WA1CGX (Boston), just to show he can do it as well as the others.

Odd how certain relatively common countries seem to elude one's grasp. G8HX worked W1, W6, W7, VK2, VK7, VK8, UK7, UK9, UM8, UA9, VE6, and XE1. The XE was the first station in Mexico to be booked into the log—and Frank has been working the DX bands since 1936!

G3DNF used his collinear for 21 MHz as the skywire with which to try out his latest QRP 14 MHz rig. However, this aerial, used on Twenty, displays a strong directional effect towards Asia, which resulted in UA9SAA being his only DX contact with the fleapower. Gordon raises a few queries about the DL QRP contest mentioned last month, on p.215. The contest call is "QRP Test." The rule about doubling one's points score, for a QSO where either end is using less than three watts seems to mean that both stations double their QSO points for that contact—at least, that's how G3KFE reads the sheet! (We get many demands/requests to print rules for this-or-that contest. Some of them are totally incomprehensible. These we ignore—or refer readers

to the originators. *Editor*).

#### Other Matters

Contests, Awards, Experiments: First, the experiment to be run by 5T5AD and 5T5CJ, on June 30, operating 5T5SOL as a beacon station during the period 0930-1130z when the eclipse of the sun is occurring, the totality being scheduled for about 1030. You are asked to listen to the beacon, sending 5T5SOL followed by a dash, every 20 seconds, on 14050 and 21050 kHz and send in reports to us, which will be forwarded to F8SH who is acting as the anchorman for the reception side of the exercise. The object, of course, is to find out what happens to propagation from an area subject to a total eclipse.

An Award now: The "Shamrock Award" is being sponsored by the Dundalk Club, rather on the lines of WAB but using the squares of the Irish grid. Details on this one can be obtained from GM3MTH, G13KVD, or G81R. Frequencies of operation, in general, around 3650-3750, nominally 3710 kHz or 7070 kHz on Forty plus-or-minus QRM.

The expedition being mounted in the second week of August by G6WGW the Blackwood Club (as mentioned last month) will be taking some HF gear to be operated

in the WAB squares on 80 and 40 metres.

Contests now: This is an advance warning of the VK/ZL/Oceania contest which has its Phone leg from 1000z October 6 to 1000z on the 7th and CW from 1000z October 13 to 1000z October 14. Exchange the usual six-digit combination of RST plus a serial number *the latter starting anywhere between 1 and 100* and rising by one for each successive contact. Score two points for each VK or ZL QSO, or one point for an Oceania contact. Total score will be all QSO points multiplied by the sum of the VK/ZL call areas worked on all bands. Logs to show, in this order: Date, time GMT, call of station worked, band, serial number sent, serial number received, points claimed. Each new VK/ZL call area worked for the first time should be underlined in the log. All entries to go to Federal Contest Committee, W.I.A., Box N1002, G.P.O. Perth, Western Australia, 6001. Entries from outside VK/ZL are to *arrive* by January 22, 1974.

The CW section of the EDXC (this is an EU event) comes up on August 11-12, and the Phone leg on September 8-9. Start is 0001 Saturday to 2359 on Sunday, all times GMT. Out of the 48 hours you use 36 hours for operating,

the rest period being taken in not more than three sessions. European stations work the world, the world works EU's. Usual five or six-digit exchange of RS(T) + serial number. Score one point per QSO, and use ARRL countries list for the multiplier, save that *call areas* of JA, PY, VE/VO, VK, W/K, ZL, ZS, UA9 and UA0 count as *countries*. In addition, the multiplier earned on Eighty may be multiplied by four, the multiplier on Forty by three, and on 14/21/28 MHz by two. Total score is QSO points *times* sum total multiplier for all bands worked. Note that non-EU stations may send back a list of up to ten stations previously worked, to score a point each for a QTC, so be ready for this to happen. (Presumably, it means that if you are told about the Contest by a DL, you make a note of it.) Logs to be in DARC form, preferably, and to be sent to DARC WAE Contest Committee, D-895 Kaufbeuren, Box 262, West Germany, to arrive by September 15 for CW, and October 15 for Phone. Incidentally, if you use your own log sheets, make them go forty contacts to the page. On the other

hand, if you are really interested, write to the QTH given, with an IRC, and ask for the rules and a supply of log sheets.

#### TVI & BCI

A write-up in the Cray Valley "Newsletter," *QUA*, discusses a lecture by G3OHX and G3VUQ, at which these two enthusiasts bombarded the meeting with practical ways of tackling TVI and BCI, guaranteeing that any case of TVI is curable, however bad the effects on the social side may be. Some staggering figures are produced—for instance, that 400 watts p.e.p. could produce as much as one amp of unwanted RF on a neighbour's TV aerial feeder! They make a valid point when they say: "Don't moan among yourselves about poor TV set design, but write to the manufacturers' organisation, BREMA, who have an Interference Committee who should be *snowed under* with our written complaints." Incidentally, BREMA is the British Radio Equipment Manufacturers Association, and their address is 31 Soho Square, London, W.1.

This whole business of TVI, as

your scribe has so often said in these pages, is almost always accepted and not dealt with; and this must have had a lot to do with the ridiculous situation that every TV set made for the U.K. market and operated from mains has a *live chassis*, which prevents earthing the chassis—that importers of foreign TV sets are refusing the anti-interference screens which the law calls for—that TV set dealers, while quite happy in many cases to sell walkie-talkies to the wrong people, are also quite happy to blame amateurs whenever their own people meet a case of interference—and that in some areas, even some G.P.O. staff on the Interference side are prepared to say "TVI is incurable." This is not at all the case and should not be accepted as such.

#### Now QRU

That's enough this time from your old conductor. For next month the deadline is to arrive by first post on July 10, the address as always being "CDXN," SHORT WAVE MAGAZINE, BUCKINGHAM, MK18 1RQ. Meantime, may your grass remain short!

#### COURSES FOR THE R.A.E.

Starting in the August issue, we will as usual begin listing those centres at which courses are to be started for the Radio Amateurs' Examination, Subject No. 765 in the City & Guilds of London Institute examination syllabus.

Those responsible for organising such courses are asked to let us have the necessary details (on a separate sheet, *please*) as soon as possible, addressed: "R.A.E.," SHORT WAVE MAGAZINE, BUCKINGHAM, MK18 1RQ.

#### "TRANSCIVER FOR EIGHTY METRES"

In this article by G3TAG, in our June issue, values for VR1 (5K log.) and VR2 (5K linear) were omitted from the table on p.223. And R2 should be 30K.

#### AMATEUR LICENCE FIGURES

There are now well over 18,000 U.K. licences in issue, about 22% of which are Class-B (VHF only). Of the total, some 3,800 are licensed for mobile, the proportion of B-licensees in this category being somewhat higher at about 24.5%. This is reflected in the greatly increased mobile activity on two metres. For the first time, we are this year getting reports of more /M's worked on Two than on Top Band, hitherto by far the band most used by mobiles.

#### RECIPROCAL LICENSING

We are informed by the Ministry that for what they call the "alien licence", U.K. licensees will in future be allowed to use RTTY and "any recognised spoken language", *i.e.*, English is no longer insisted upon as the only language to be used over the air by foreign amateurs licensed in the U.K.

#### MORSE AT MABLETHORPE

Under the guidance of a professional operator, it is intended to organise a class in Morse tuition at Tennyson School, Mablethorpe, Lincs., as part of the winter evening educational programme. For details, contact P. J. Bradshaw, G8AWX, 46 Camelot Gardens, Sutton-on-Sea, Mablethorpe, Lincs., LN12 2HP, enclosing an s.a.e.

#### ENSIGN ELECTRONICS, QUORN, LEICS.

Due to the untimely death in a motor accident of the proprietor of this firm, all business outstanding is being dealt with by his father, Mr. P. R. Twells, 18 Chaveney Road, Quorn, Nr. Loughborough, Leics., to whom applications should be made with reference to completion of orders or refunds of cash paid.

## GENERAL COVERAGE RECEIVER

### CONCLUDING POINTS

We now go on from p.230 of the June issue, on the subject of IF alignment.

With crystals in use, the procedure is the same, except that the IFT's have to be centred between the crystal frequencies. This is most easily done by shorting VC1, and injecting from a signal generator at 2 of V1, swinging the generator from about 464 to 466 kHz, as necessary to find the crystal peaks. Then set the generator between these, and adjust the IFT cores as mentioned. With patience, a similar result can be achieved by tuning in a stable BBC signal, and adjusting the IFT cores. With correct adjustment, selectivity should be quite a notable feature.

#### Band Coverage

Band coverage at the LF ends of the bands can be altered by moving the cores L5, L6, L7 and L8, as required. At the HF ends of the bands, adjust T5, T6, T7 or T8, as necessary.

#### Aerial Alignment

If necessary, adjust L1, L2, L3 or L4 at the LF end of the band, for best results. If required, adjust the appropriate aerial trimmers T1, T2, T3 and T4 near the HF end of the

bands.

#### Aerial

For general use, any end-connected wire can be used. But a properly erected aerial, designed for all bands, or operated in conjunction with a tuner, will *greatly* improve results. A very long aerial, of no specified or known characteristic, will add considerably to 2nd channel whistles. A shorter aerial is much less liable to this trouble. Placing a pre-set capacitor in the aerial connection at A will improve results. Best results of all will be with a resonant tuner, which can be operated in conjunction with an end-connected aerial, or tuned couplet, or other tuned system, in the usual manner.

#### To Repeat

It ought to be noted again that this circuit was used with the aim of producing an essentially simple receiver, based on a home-made coil-pack, which is put in as a ready-made and approximately aligned unit. The limitations imposed by lack of pre-mixer selectivity have been described. But, as also noted, there are various quite expensive receivers on the market with a 470 kHz IF and no extra 2nd channel rejection than has this receiver.

As regards adjacent channel selectivity, that exhibited by this circuit is of course much better than that of the type of commercial receiver with which it is being compared. In fact, if the crystal filter is omitted, this receiver will have about the same adjacent channel selectivity as a very large number of commercial receivers, including certain models which are in much general use for amateur and all-band coverage.

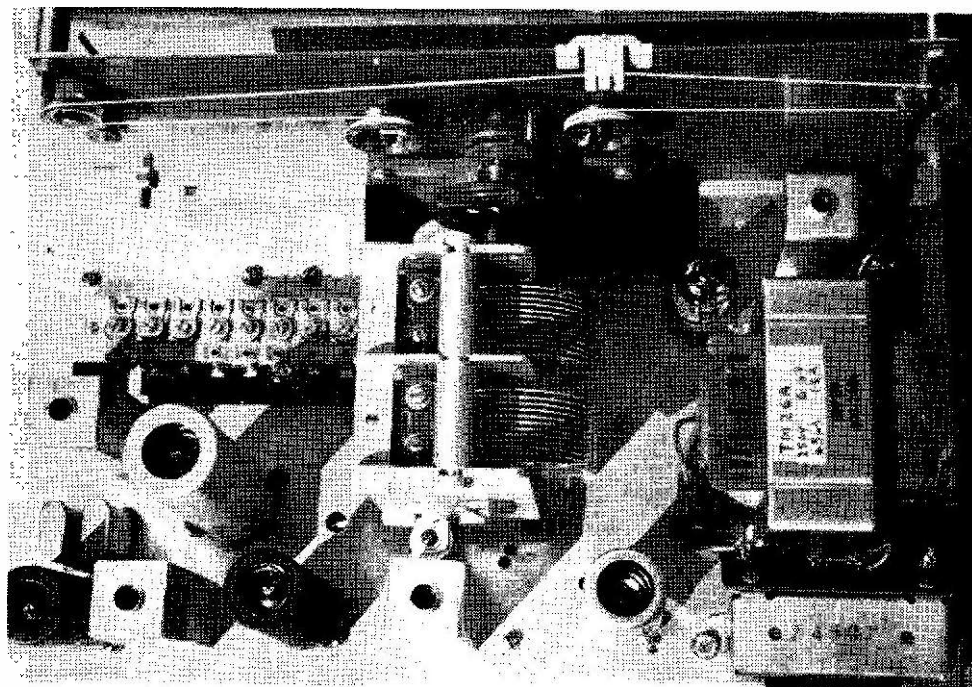

*Another interior view of the Rx as described*

## BOOK REVIEW — 1973 ARRL HANDBOOK

BEFORE settling down to review the 1973 (50th) Edition of the ARRL *Radio Amateur's Handbook*, your reviewer compared it with some of the earlier editions on his shelf, dating back to 1939. About the only thing in common with these earlier editions is the page size and the soft cover. Compared even with so recent an issue as the 1971 *Handbook*, this new one is very largely rewritten. Emphasis has been laid on the modern developments, so that, for instance, Fig. 8-8, covering "detectors," shows types using a valve, a bipolar transistor, a FET, a diode, or an IC. Similarly with the drawing of various types of mixer. A section now deals with digital IC's, and another shows some of the many ways of using the operational amplifier type of IC. When one looks at VHF pre-amplifiers, there is not a valve to be seen.

Chapters are not in their accustomed order, neither are the titles of the chapters the same—and the advertisement section has disappeared altogether. A sign of the times is a list of American companies willing to accept small-number orders from amateurs for components—it seems that problem is not only confined to Britain!

Of course, many buyers of the *ARRL Handbook* (as it is usually known) are professionals, who find it a worthwhile volume of information to have on desk or lab. bench at work; for them also, the 1973 Edition out-dates all the earlier ones because of its extensive modernisation, and indeed since your reviewer took his to work for a lunchtime read, three people in a lab. of twelve, all non-amateurs, have asked him to get a copy for them for reference, after borrowing it for long enough to get a good "feel" for the contents.

Perhaps the most interesting thing for most people is to note that the chapter on Interference now carries notes, not only on BCI and TVI, but also interference to Hi-Fi equipment and electronic organs. However, for your reviewer, the most interesting item by far is the RF Impedance Bridge, giving indication of both resistive and reactive components to a degree adequate for use with a Smith Chart—this can revolutionise our amateur ideas on Aerials and their measurements.

To sum up: Speaking as a professional as well as an amateur, your reviewer is torn between keeping his copy in the shack, or on his desk at work.

The ARRL *Radio Amateur's Handbook*, 50th edition, 1973, of nearly 700 pages, covering design, construction and operation of amateur-band equipment of every type, fully illustrated in line and half-tone, indexed, price £2.85 in limp cover (or £3.65 hard back) post free, from stock, of the Publications Dept., Short Wave Magazine, Ltd., 55 Victoria Street, London, SW1H OHF. *E.P.E.*

## AS IT WAS IN THE BEGINNING

## NOTE OF NOSTALGIA

J. W. PADDON, G2IS

COMMUNICATION was first carried out (by the writer) by what can be properly described as a pulse train having constant amplitude and varying lengths. That was half a century and five years ago. The propagation medium was two strands of a barbed-wire fence running through the Ontario bush from my back door to that of a friend on the other side of the hill. QSO's were solid—no QRM, no QRN and no QSB. The power supply was half a dozen dry cell batteries. A key and a telegraph sounder at each end completed the system. We learned Morse from the operator at the local railway station who was bored, underworked and liked children.

When my friend moved away the urge to communicate was in no way abated. To fill the gap attention was turned to wireless (who ever heard of "radio" then? That word came into being many years later). There was little technical literature available. Gear was nearly non-existent and what there was priced far beyond the resources of a youngster.

Things really got going when an amiable Aunt returned from a visit to England with a present in the form of a pair of headphones—excellent ones from a manufacturer who, happily, still flourishes. About the same time an article on how to build a receiver appeared.

In those days it was overwhelmingly L and precious little C. What C there was came from the antenna/earth capacity except for the capacitor across the headphones. Fine DCC wire was readily available as was galena crystal. With a little more trouble some square brass rod and sliding contacts to run on it were found. A large, cylindrical cardboard box (which originally contained oatmeal) was heavily painted with orange shellac and baked in a low oven. Turn by turn the winding was put on—hundreds of turns. Two square pieces of wood made the end supports for the coil. A couple of careful passes with a red-hot poker burned away the insulation and provided a path for the sliding contact. Thus was produced the "tuner," to load the antenna. A similar device but with two sliders on completed the great hunk of inductance. A by-pass condenser for the headphones was dug out from a Model "T" Ford sparking coil salvaged from the local garage junk heap.

The final problem was the aerial. In those days they were heroic affairs made up of six parallel wires on twenty foot spreaders. That meant 12 insulators. These looked like baked mud cricket balls with a screw eye on each side. The cash to buy these was raised by picking innumerable boxes of strawberries at 2d. each. The contraption filled the hundred and fifty foot space between the peak of the barn and a big fir outside the shack window. Earth was the casing of a deep well and probably a good one for the pipe went straight down sixty feet.

### Putting It Together

Soldering up the connections was an interesting job. The bit of the iron was a one pound lump of copper and was heated in the fire box of a wood-burning kitchen stove. Soldering paste had never been heard of. Flux was made by dissolving slips of zinc in muriatic acid which made a good joint but flew sizzling in all corrosive directions when the hot iron was applied. Solder came in great hefty bars meant for plumbers.

The great moment finally came. Connections were checked and the shiny new headphones clamped over the ears. Total silence until a few prods with the cat's whisker found a sensitive spot on the crystal. There were thunderstorms about so above the background hiss there were reassuring crashes of static—and nothing else. After dark and much patient juggling with the sliders a Morse signal finally emerged. Faint it was but going steadily along at an easy pace. Utter frustration set in for not one scrap of sense could be made of it—not surprising for this was international Morse and not the familiar continental. It took some time to find out that this code even existed but a chance meeting with a fellow who worked for Marconi somewhere up the St. Lawrence solved the riddle and provided a copy of the "wireless" code.

### Results!

The tedious business of learning this new code began. There was no one who knew the code for hundreds of miles so the instructors were: FL, the Eiffel Tower; POZ, Nauen in Germany; and NAA, the U.S. Navy station at Arlington, Virginia. The signals they put out were actually machine made, generated by Alexanderson or Goldschmidt alternators. These were towering contraptions which, by the use of high rotational speed and an enormous number of field coils produced at VLF, AC current which could be made to radiate. Keying was achieved by exciting the field coils and the hysteresis of the iron in the system held the code speed down to a low enough figure to enable a patient and persistent youngster slowly to learn it. The highest frequency they could achieve was 200 kHz but in practice they worked on a far lower frequency. The wave form was so full of overtones and other anomalies that it ceased to be pure CW and could be copied without a BFO.

It is an interesting historical fact that after Pearl Harbour the U.S. Navy dug out an alternator left over from the Kaiser's War. This was on the Island of Hilo. After shovelling away the accumulated rubbish of years the machine was cleaned up and the windings dried out. It fired up on the first twist and provided solid VLF all over the Pacific until the end of hostilities with Japan.

That was the way a career in Amateur Radio began. Perhaps there was more satisfaction in it than there is today. It developed an amateur population without passengers. Those who wanted it the easy way soon dropped out. The few who stuck it out were a close-knit band of enthusiasts. Unlimited help was poured out upon anyone who asked for it. While QSO's were very few and far between each one was an event and an achievement far beyond a two-hour, ten-station round-table on SSB.

### REDIFON TELECOMMUNICATIONS EXHIBITION

London, June 5-8

**A**LTHOUGH Redifon products are beyond the financial resources of most amateurs, the Redifon '73 Exhibition had much of interest for the electronically minded. Attracting a great deal of attention were the new, solid-state, broadband, HF amplifiers rated at 400 watts and 1 kW. The latter has no less than 48 transistors

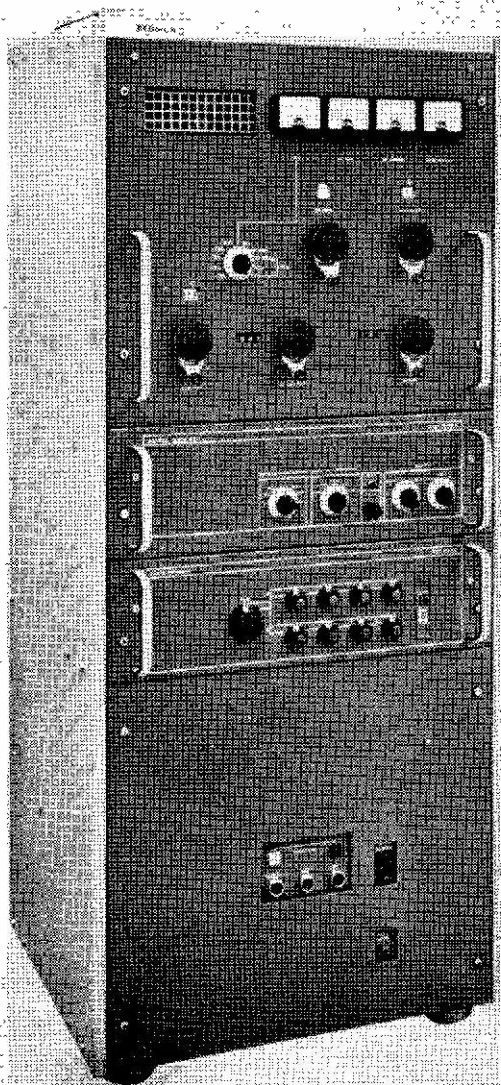

The new RMT-1500S frequency-synthesised 1.5 kW marine-band SSB transmitter by Redifon Telecommunications, Ltd. see text.

The RMT-1500S frequency-synthesised 1.5 kW SSB marine transmitter installed in the radio room of the new B.P. tanker "British Tamar", GPIL, which is fitted with Redifon Telecomms. equipment.

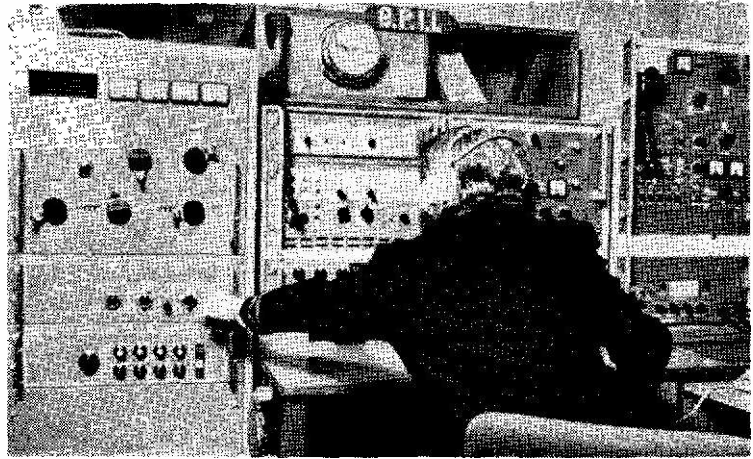

in the output stage arranged round the periphery of a drum, a layout which not only gives even cooling, but is also electrically convenient. The problems of matching and balancing are obviously formidable, but the modular construction eases the servicing problem. Full protection against short circuited and open-circuited antenna conditions provides an additional safeguard against catastrophic misuse.

A new marine transmitter, designated the RMT-1500S, runs up to 1.5 kW on all marine radiotelegraph and radiotelephone bands with a frequency stability of 1 part in  $10^7$ —or about 2.5 Hz at 30 MHz—more than adequate for selective calling and RTTY working. The frequency is selected in 100 Hz steps from a synthesiser so designed as to permit the setting up of a working channel as well as a calling channel, the former becoming available, once communication has been established, merely by pressing a button. Modes available from the synthesiser, which is a standard piece of equipment producing 100 mW of output and capable of driving a number of transmitters of varying output powers, are A1, A3A (SSB with pilot carrier), A3H (SSB with equal carrier for DSB), A3J, and A2H (one sideband with equal carrier for MCW transmission). The idea of using a small drive unit with multiple facilities also has much to commend it in the amateur context and, with the addition of NBFM, can be used to produce all the usual modes on various amateur bands by appropriate mixing and linear amplifier techniques.

Other new Redifon products were a mobile, all solid-state, 400-watt HF transmitter covering the usual range of HF communication frequencies, an automatic alarm receiver operating on the international distress frequency and, a sign of the times perhaps, an audio entertainment and intercom. system for small vessels.

A surprise announcement came from the Managing Director of the company, Mr. J. R. Brinkley, that Redifon are going into the mobile and fixed station VHF/UHF market—quite a departure from previous policy, but one which is in line with Mr. Brinkley's previous interests.

Although some £100,000 per annum is being invested

in this project, it will obviously be some time before the ubiquitous Rangers and Cambridges, so popular for amateur mobile working, are supplanted.

A.H.D.

#### SPECIALLY ON THE AIR

Quite a number of new entries under this heading, all in connection with events at which the public will be present in large numbers. In some cases, the exhibition station is put on with the intention of attracting mobile operators, *i.e.*, talk-in facilities are offered for possible /M's. In fact, some of these events could assume the proportions of a Mobile Rally, though probably without the trade stands of radio amateur interest now associated with Rallies. In each case, the name/QTH given is the address for QSL's.

**GB3HCW, June 30-July 7:** Operating all bands Top to two metres, with three stations on the air. This event is in conjunction with the Hanworth Carnival Week.—V. W. Higgs, G3VWJ, 205 Commercial Road, Staines, Middlesex, TW18 2QT.

**GB3MKB, June 30-July 7:** At Ballycastle, Co. Antrim, to commemorate the 75th anniversary of the Marconi link to Rathlin Is., operating all bands 10-80m., with a special QSL card. (This station should be worked for the "G16YM Golden Jubilee Award").—J. Beattie, G13NQH, 170 Lower Braniel Road, Belfast Northern Ireland.

**GB2DTS, July 7-8:** Put on by Barking Radio & Electronics Society for the Dagenham Town Show, running all bands 2m.-160m. inclusive, with talk-in for mobiles on 145 MHz.—R. E. Clark, G8BXC, 62 Waltham Road, Woodford Bridge, Essex.

**GB3SF/G, July 12-14:** Finchley Carnival at Victoria Park, Ballards Lane, London, N.3, operated by the Southgate Radio Club, all bands 2-160m.—A. C.

- Edwards, G3MBL, 244 Ballards Lane, London, N12 0EP.
- GB2FS, July 14:** Organised by Farnborough & District Radio Society for Frogmore School fête, to work on 80m. and the HF bands.—D. Underwood, G3MBK, *QTHR*.
- GB2RHR, July 14-15:** For the Robin Hood Vintage Car Rally, Wilford Lane Sports Ground, Nottingham, with SSB 10-80m. and AM on two metres. All contacts will be QSL'd by special card.—A. Veitch, G8FRB, *QTHR*.
- GB2SCW, July 19-21:** Put on by the Stowmarket District Amateur Radio Society for the local carnival week, running 20-160m. and 2m./70cm., CW and phone, from the Recreation Ground, Stowmarket.—K. J. Bertrand, 35 Cuewen Road, Stowmarket, Suffolk, IP14 1JX.
- GB3SS, July 22:** At the Polegate Steam Engine Rally, off the A.27 Polegate-Lewes road, with talk-in on 2/4/160m., also an HF band station signing GB2SS.—B. Houghton, G4BCO, *QTHR*.
- GB2BEX, from mid-July:** In connection with the "Bristol 600" charter celebrations, organised by the Shirehampton Radio Club, working all bands, contacts to be QSL'd by a special card.—A. H. Kelle, G4AYB, 48 Station Road, Shirehampton, Bristol, BS11 9TX.
- GB3BSI, July 28-August 4:** Operating from Brownsea Island, Poole Harbour, Dorset, running 10-80m. SSB and AM/FM on 2m./4m.—P. Dutfield, G3OBD, 16 Talbot Drive, Poole, Dorset.
- GB2SJC, July 28-August 4:** For the Welsh Scout Jamboree at Penryn Castle Park, Bangor, North Wales, for which a large number of Scout campers is expected. A CW/SSB station will be operated on all bands 10-80m., for which some volunteer Licence operators and SWL assistance, with logging and QSL card work, would be appreciated.—D. Roberts, GW3UBV, 33 St. Martins Park, Haverfordwest, Pembrokeshire.
- GB2GB, August:** Station to be operated from Brunel's famous old steamship *Great Britain*, now dry-docked, at Bristol, for the City's charter anniversary celebrations. GB2GB will be available for operation by visiting licensed amateurs during the entire month. Contacts will be QSL'd by special card. Information from G. Mather, G3GKA, 8 Hills Close, Keynsham, Bristol.
- GB2YEO, during August:** From the Yeovil Technical College, running all bands 10-80m., also two metres.—D. L. McLean, G3NOF, 9 Cedar Grove, Yeovil, Somerset.
- GB3RAF, August 10-27:** In conjunction with the R.A.F. Exhibition, Billesley Common, Birmingham, operating on HF and VHF from the exhibition site, 10 a.m. till 8.0 p.m. daily. Operators will be R.A.F. personnel.—Hon. Secretary, R.A.F. Amateur Radio Society, R.A.F. Station Locking, Weston-super-Mare, Somerset. (*Call GB4CES may also be used*).
- G3CAR, September 1:** For the 27th annual Wycombe Show, at The Rye, High Wycombe, Bucks., organised

by the Chiltern Amateur Radio Club, to operate CW/SSB on all bands 10-80m. RTTY skeds would also be welcomed. QSL by a card minted for the occasion.—A. C. Butcher, G3FSN, 70 Hughenden Avenue, High Wycombe, Bucks.

Any further notices that are wished for under this heading should be in the form shown here—in particular, we must have the name/QTH of whoever is to be responsible for handling enquiries and the QSL card business. We cannot accept notices that do not include this information. Address to: "Specially on The Air," SHORT WAVE MAGAZINE, BUCKINGHAM, MK18 1RQ.

---

### WHAT SOME READERS SAY

" Thank you for all you have done for me; I knew nothing about Amateur Radio till I picked up a copy of your Magazine on a station book-stall. Now I have my own call sign . . . "

"—I am professionally interested in radio but I like your amateur Magazine because it is written in English . . . "

"—While I have learnt a lot from SWM, I think you should pay more attention to beginners . . . "

"—I am getting tired of your Magazine because you devote so much space to the SWL interest . . . "

" Thanks to your SWL feature, my son and I now have a joint station for logging DX on the amateur bands . . . "

"— Because my main interest is VHF, I am not renewing my subscription . . . "

"—I think you devote far too much space to VHF, which is surely not the main activity of DX-minded amateurs . . . "

" I would like to ask you to cut you the Clubs article, and who works what on the HF bands. This is surely old stuff. I would like to see more technical articles . . . "

"—Your articles are far too technical for me . . . "

"—The first thing I turn to is your DX commentary; it tells me just what I want to know about what is happening on the bands . . . "

"—You should pay less attention to valves and more to transistors . . . "

"—You publish a lot of articles using transistors but seem to forget that many ordinary radio amateurs still understand valves, of which they have hundreds in their junk boxes. . . "

"—It is easy to talk about anti-TVI measures but a great deal more difficult to deal with neighbours who complain if you have planning permission for a beam in your garden . . . "

[over

" You should devote more attention to BCI/TVI. I live on a housing estate and just don't know to cope with the problem . . . "

" - The local Post Office engineers have been most helpful and co-operative in dealing with my TVI difficulties . . . "

"—I have to thank you for opening up an entirely new field of interest in my enforced retirement . . . "

"—You should not worry about criticism. You do

a good job for Amateur Radio and I have been a reader for more than 20 years . . . "

(As we have on occasion remarked, we cannot hope to please everyone all the time, but we do try to catch the interest of most of our readers for at least some of the time. The foregoing comments are *verbatim* extracts from letters received over the last three months or so—and we have many more such! *Editor*.)

## QRO LINEAR FOR TWO METRES

### CHOICE OF CIRCUITRY AND DESIGN FOR PAIR 4CX250B

#### Part I

J. D. V. LUDLOW (GW3ZTH) and  
C. J. DUNBAR (GW8EHK)

*Some detail drawings and illustration will follow in Part II—Editor.*

AS a result of observation made over a considerable period on two metres it became apparent that certain stations over two hundred miles away could always be heard even under normal conditions; very often these stations could not be raised using 200w. p.e.p. input. Subsequently it was determined that these stations were using high power linear amplifiers and were, in some cases, being heard off the side of their beams! Similarly the converse is true, that the other station would stand more chance of hearing and replying to CQ calls if higher power were available.

Another factor that has to be considered is that in certain areas of the United Kingdom the local terrain has great attenuating effect. The use of higher c.r.p. over these paths certainly produces more contacts and to a great extent reduces the depth of fading on these long-distance signals.

Communication *via* the Auroral curtain and meteor trail ionisation (MS) is rarely possible from GW3ZTH using CW, leave alone SSB. However, it is likely that the highest powers are necessary to achieve this at all successfully.

The methods of increasing one's e.r.p. are twofold:—

Modification to the station's antenna system would involve putting twice as much metal up in the sky to achieve approximately 3 dB power gain.

This was seriously considered because any gain realised would be useful on "receive" as well as "transmit." However, in the author's case this would involve considerable mechanical engineering and so the choice was made to construct a high-power linear amplifier.

On the other hand, it should be noted that the use of high power does have disadvantages:—

- (i) The incidence of TVI does appear to affect those stations who consistently run higher powers to a greater extent than other stations, the problem usually being overload of the TV Rx. front end and/or breakthrough,
- (ii) The high probability of overloading the mixers of poorly designed local two-metre receiver/converter set ups with the resulting complaints of "excessive power," "bad signals", "spurious products," etc., causing strained relations between oneself and the locals,
- (iii) The cost of constructing, maintaining and even running such an amplifier must be considered as a disadvantage,
- (iv) The element of danger involved during the alignment of the amplifier and in the general lay-out of the station supplies which are potentially lethal is yet another disadvantage.

With the above in mind the project was undertaken in the winter of 1972. There are few articles available on 2m. linear amplifiers and only two were referred to, these being in the *VHF/UHF Manual*, and the other in the A.R.R.L. *Radio Amateur's VHF manual*. Both of these complement each other but omit some salient points. These the authors hope to make without omitting any of the others.

### Table of Values

Fig. 1. Circuit of the QRO Linear

C1-C15, incl. — .001 $\mu$ F 500v. disc ceramic	FT1-FT5 incl. — .001 $\mu$ F 500v. bolt-in feed-thru
C12, C13 — 68 $\mu$ F 8 kV wkng., disc	R1, R2, R3, R4 = 150-ohm 2w carbon
VC1 — 15 + 15 $\mu$ F, split stator	R5 — 25-ohm 10w. w/wound
VC2 — <i>to be described</i>	L1 — 2 turns 16g., $\frac{1}{16}$ in. dia.
VC3 — 15 + 15 $\mu$ F butterfly	L2 — 3 turns 16g., $\frac{1}{16}$ in. dia., tapped at 1t. ( <i>see text</i> )
TC1, TC2 — 0.3-6 $\mu$ F ceramic tubular	L4, L5 — <i>to be described</i>
TC3, TC4 — 0.2-5 $\mu$ F min tubular	V1, V2 — 4CX250B, with base and chimney

NOTES: Screen decoupling capacitors C in diagram Fig. 1 are built into 5K610 valve holders for 4CX250B. Shunts MS1-MS5 should be carbon, valued to suit meters used. Capacitors C12, C13, rated 8 kV, can be *Radio Spares* "disc-ionisation free" items. Drawings for inductances L4, L5, will be given in Part II. Coils L1, L2 are also covered above.. R5 is in effect an RF choke.



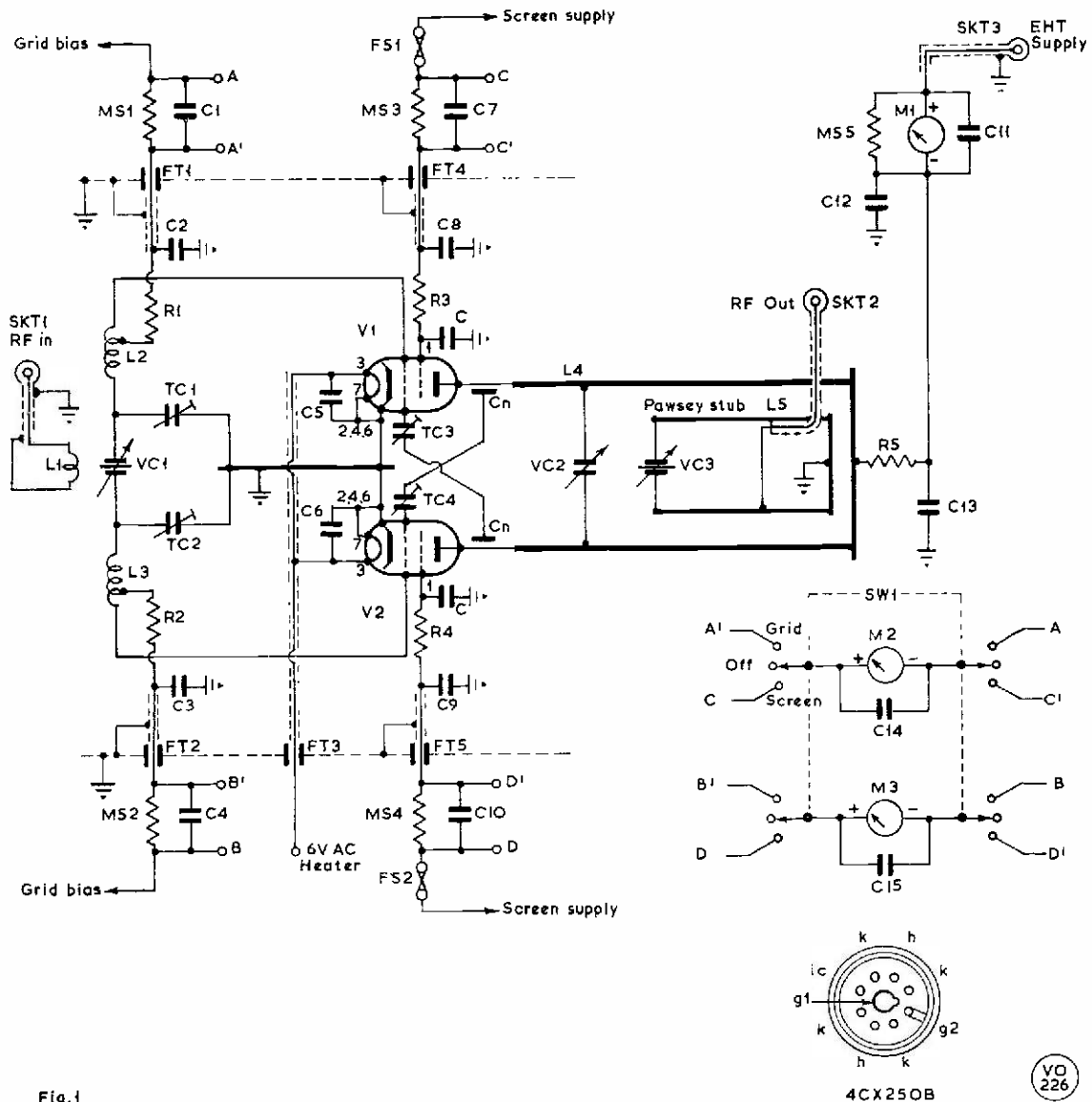

Fig.1

Fig. 1. Basic circuit of the two-metre high power Linear Amplifier

The basic design was initially determined by two factors—one being the type of anode lines and the other the space available in the shack.

Any amplifier of this type has to be made physically large, as not only is there a heat problem but also one of high RF fields. As the effect of high RF currents appearing in the metal box can be disastrous the amplifier was built into a box of 17 x 10 x 4½ inches, with a front panel of 19 x 8½ inches, these being manu-

factured professionally. The amplifier is mounted in the box, open side uppermost, with the 4CX 250B air system sockets mounted on a vertical 4½ in. high partition having its edges folded over and drawn in tight to the amplifier box side walls to form an effective air seal.

The box top plate was split into two, the blower being mounted on the one above the grid compartment leaving the only path for the air flow through the 4CX250B air system sockets and the valve anode coolers; this cover

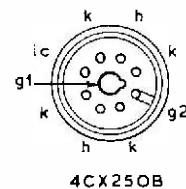

VO 226

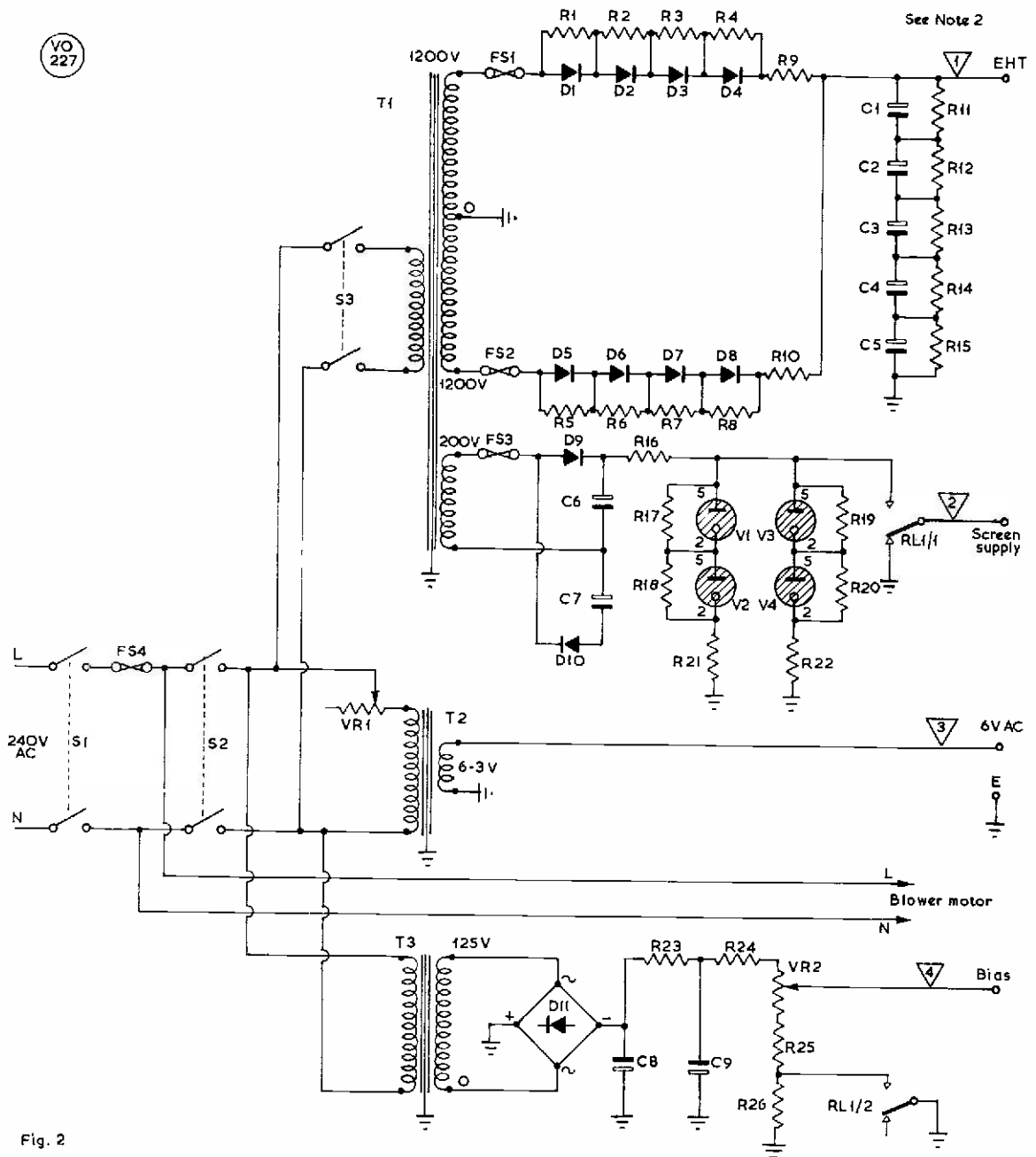

Fig. 2

Fig. 2. Suitable power supply unit for the QRO Linear Amplifier

was air sealed with the normal household self-adhesive draught excluder which was obtained from a local D.I.Y. centre for a few pence.

Large anode lines were used because it was felt that

they would aid in removing the heat dissipated by the valves. The anode lines were therefore made of copper pipe with a nominal 1½ in. bore. This material was obtained from a local central heating firm.

**Table of Values**

Fig. 2. Circuit of The PSU

C1-C5, incl. — 100 $\mu$ F, 450v. elect. C6, C7 — 32 $\mu$ F, 450v elect. C8, C9 — 16 $\mu$ F, 450v. elect. R1-R8 — 220,000 ohms, 2w. incl. R9, R10 — 50-ohm 10w. w/wound R11-R15 — 110,000 ohms. 4w R16 — 5,000-ohm, 30w. R17-R20 incl. — 150,000 ohms, 2w R21, R22 — 150 ohms, 2w. R23 — 680 ohms, 2w. R24 — 15,000 ohms, 2w. R25 — 2,200 ohms, 2w. R26 — 10,000 ohms, 2w.	VR1 = 500-ohm 25w. w/wound VR2 = 10,000-ohm 3w. w/wound RL1, RL2 = 2-pole c/o with heavy duty contacts D1-D8 incl. = 1N4007 D9, D10 = BY100 D11 — Bridge rectifier, 400 p.i.v., 500 mA T1 — Sec's 1200-0-1200v 1 amp and 0-200v 120 mA T2 — Sec. to give 6.3v at 5 amp T3 = 0-125v. 50 mA.
--	--

NOTES: Transformers T1, T2, T3 have standard primaries. FS1, FS2 should be rated 500 mA anti-surge, and FS3 250 mA. Switches S1, S2, S3, should be heavy-duty DPST, rated 6 amp. at 240v. Resistors R11-R15 can be built up by putting 220K resistors in parallel. R16 can be three 15K 10-watt wire-wound resistors in parallel.

The decision to tune the lines with a flap was dropped in favour of discs, because of the height limit set on the box. However, if the would-be constructor has more space available a flap is recommended because it avoids hot spots being developed at the disc-supporting bushes.

Drawings were made up for the lines. These were then prefabricated by mounting them together with the end plate in a jig to keep them square. They were then soldered together using a blow torch. It is best to silver solder the lines but normal radio solder can be used with equal success.

The tuning discs were made out of scrap  $\frac{1}{8}$ in. copper plate by using a tank cutter. They were then soldered onto  $\frac{1}{4}$ in. brass studding which had been previously

mounted through the lines. The finished product was then cleaned up and the anode ends of the lines were fluted to take the anode coolers of the 4CX250B's, these being clamped in place by Jubilee clips.

The lines were to have been held in place by means of a tufnol plate across the width of the box, but this was dropped because of the difficulty in getting the lines out for valve changing. The present arrangement consists of two tufnol plates supporting the ends of the line.

Because the lines were slightly too long in the authors' case a copper shorting strap of one-inch flashing was made up, and works well. However, this needs to be a good fit and high grade copper is necessary. Should lines with different dimensions to those specified be used then a simple check will show if an alteration is required. Assemble the anode lines (without soldering the end plate in place) in the box with valves and supporting brackets and check the resonant frequency with a GDO. No supply voltages are needed for this check, but since the top cover and Pawsey stub effect the resonant frequency allowance must be made for them.

Initially, a coupling loop was made out of  $\frac{1}{4}$ in. dia. copper tube (pyrotenax cable) but this was later abandoned in favour of the Pawsey stub as the latter was found to be more efficient in getting all the RF out from the tank circuit. It is interesting to note that others have also found the ARRL arrangement inadequate.

The Pawsey stub was also made out  $\frac{1}{4}$ in. dia. copper tube (pyrotenax cable) which was suspended from the underside of the lid of the anode compartment. Care must be exercised to prevent accidental shorting to the lines when the lid is in place.

No attempt was made to balance the lines with individual capacitors as it was not needed. A suitable choke (R5) and careful adjustment of TC1 and TC2 practically eliminate the effect of any slight unbalance providing of course that R5 is not decoupled at its hot RF end.

The grid circuit is a coiled up half-wave line, being only slightly less efficient than its straight out counterpart and it occupies far less space. It is formed by winding a 6-turn coil of 16g. copper on a  $\frac{3}{16}$ in. mandrel with  $\frac{5}{16}$ in. spacing of turns and long tails. The coil is then cut in half so forming two separate windings. These are mounted so that the grids of the 4CX250B's are connected to their outer ends and VC1 the split-stator tuning capacitor, to the inner ones. The correct point of connection of the bias feed resistors R1 and R2 should be determined by monitoring the grid current whilst touching a lead pencil along the grid coils, the correct point of connection being where *no* reaction of the grid current is observed. The use of carbon resistors here and for feeding the screens is a "must" if parasitic instability is to be avoided. The input coupling loop L1 is a two-turn link and is adjusted for maximum grid current during the initial testing.

The grid circuit is balanced by two small tubular Mullard trimmers TC1 and TC2 instead of the more usual differential trimmer—this arrangement gives excellent results and no problem has been experienced in balancing the grid circuit. It should be pointed out that both the rotor of VC1 and VC3 are left ungrounded, as grounding them may severely unbalance the circuit.

TABLE I

	Receive	Transmit	
		ZERO SIGNAL TOTAL ANODE CURRENT=100 mA	SINGLE TONE I/P 400w. RF OUT.
(1) EHT	1800v.	1675v.	1500v.
(2) Screen Supply	Zero*	330v.	329v.
(3) Heater	5.8v. AC	5.8v. AC	5.8v. AC
(4) Grid Bias	-80v.	-55v.	-55v.

\*Screen grids earthed via relay contact—as per text.

Readings derived from the PSU of Fig. 2.

(To be concluded)

# • • • SWL • • •

## SHORT WAVE LISTENER FEATURE

By Justin Cooper

### PROPAGATION FACTOR — MODERN RECEIVER CONSTRUCTION POSSIBILITIES - DISCUSSING READERS' LETTERS — LATEST LADDER LISTINGS

**P**ROPAGATION affects our activities from Top Band down to Ten. On these bands, as we know, it is possible, by selection of band and time, to hear stations on the far side of the Earth. How is this achieved?

Our globe is encircled by layers of ionised air at different heights above ground—layers which are ionised by the action of the sun. The layers of interest to us are designated D, E, and F layers, with the latter sometimes splitting into upper and lower levels, the former being the F2 layer and the latter F1 when this occurs. All the layers are affected by daylight, the lower ones indeed almost disappearing by night.

Now, the lower, D and E layers, are primarily absorbers of radio signals, the absorbent effect increasing at the lower frequencies; this results in the well-known effect whereby Top Band and Eighty will only support propagation to distant parts normally at night. At the higher frequencies the absorbent effect is least and the DX is there by day. The actual reflection, or, rather, refraction (the wave is bent round rather than abruptly reflected) occurs at night in the F layer, and by day in the upper, F2, layer when F1 and F2 layers are in existence together. Thus, the higher bands are less absorbed and can reach the F or F2 layer by day to be refracted, while lower frequencies can only reach the F layer and be bent back by night.

The ionised layers are collectively called the *ionosphere*, and are subject to several factors. The prime one is the effect of the sun's rays. Additionally, there is an effect directly connected with the presence of sunspots, ionisation being greater when more sunspots are present, and there are monthly and seasonal changes as well.

Broadly speaking, we prefer on the lower-frequency bands to have an all-darkness path, and on the higher an all-daylight path. Depending on the degree of sunspot effect, Forty and Twenty may support communication by day or by night and so fall midway between the two extremes. Furthermore, at times when the sunspots are few (at the trough of the 11-year sunspot cycle) the ionisation may not be enough to support *any* long-distance communication on Ten, or even Fifteen. As more sunspots appear, Ten will open up North-South for an hour round noon, while Fifteen may be good all round. At the peak, Ten will still be a daylight band, but Fifteen may be open well after dark, while Forty will take on something approaching the characteristic

of Eighty. An additional effect is that dawn or dusk at one or both ends of a path will often produce a peak in propagation effect.

Summing up, the SWL can see that a change in listening hours will very likely produce a change in the type of DX heard—and that there are best times for switching on the receiver if one wishes to hear a particular part of the world.

### Some Newcomers

Odd are the ways in which people come to Amateur Radio. *W. Baker (Bognor Regis)* was in hospital and made friends with a couple of other chaps; they all had had an interest in the idea of Amateur Radio but had not done anything about it. On their release, the three decided to "have a go"—and may we hope to hear more of them.

*M. Wickstead (Taplow)* has returned to the fold after some years' absence, and is mainly interested in Mobile and RTTY operation. *Maurice* has a Trio 9R-59DS, whose potential is as yet only partly plumbed: but he knows what to look for as he is professionally occupied in the communications field.

Another newcomer is *H. Houghton (Worcester)*, who has a National 100X general-coverage receiver and, more recently a Trio 9R-59DS. On the VHF side, there is a DL6SW converter on 144 MHz with crossed dipoles in the loft.

*C. M. Little (Croydon)* has at least one "phoney" in his list, in the shape of "AC4RF" whose real-life existence was way back in the late Forties; *Bob Ford, AC4RF*, was captured by the Chinese and later wrote a book about his experiences, both in Tibet and in Chinese hands.

A Unica UNR-30 with a 14 MHz folded dipole is used by *P. Davies (Stoke-on-Trent)* who has been a listener for two years now.

We mentioned *M. Smith (Matamata, New Zealand)* last time, as far as his rig goes; this time he has sent in a list of Prefixes of which several are queried, all being OK saving "VK9R" who we reckon is more likely VQ9R. On the aerial front there is a twenty-foot pole which is to be adorned with a TH3 beam; then there is a "cats cradle" to which is added a 14 MHz dipole.

*C. L. Lee (Ilford)* has a nice collection of 367 prefixes for the Table, heard on all bands with a Drake R4A receiver and 150-foot wire aerial.

Back in November 1971 was when *P. Eaton (Folkestone)* made a start with listening. Paul uses a home-brew transistor receiver in conjunction with a 14 MHz inverted-Vee and a 66ft. end-fed aerial to choice, the operation being mainly on Twenty, but a little on 7 and 3.5 MHz.

Miss K. Ramsay (London S.E.12) has a CR-100 receiver used in conjunction with a DL6SW converter and halo aerial, or alone to a sixty-foot wire. Karen says she has had much help from the local VHF licensees, and is going to R.A.E. classes and Cray Valley Club meetings—she says her repayment is to make coffee and provide moral support when contests do not go so well for the local lads!

What is the reason for the use of the DT prefix, wonders M. Whitfield (Stroud) in the covering letter with his Table entry of 467 prefixes. Easy, Malcolm, this is a "special" used by stations in the German Democratic Republic (East Germany), to commemorate 20 years of Amateur Radio activity.

### Other Reports

A goodly collection of DX in any language has been garnered by A. Judge (Bishops Stortford). Tony raised a smile when he suggested that maybe the IT57 prefix from Sicily might have some connection with a well-known baked-bean firm!

People get their prefixes in some odd ways. M. Kitchener (Hitchin) had been pretty inactive for a period, but was asked by a local G8 to demonstrate his new cassette tape-recorder. To do so, Mick recorded some SSB from 21 MHz and the Trio receiver. When they played it back, it occurred to Mick that this was an odd signal—sure enough, on looking it up he found he had a new prefix to count!

Like so many others, P. L. King (Emsworth) has found DX conditions pretty poor—a combination of solar activity and the low summer MUF's account for most of our problems and will continue to do so for a while—and has also suffered from lack of time. However, the enthusiasm is still there, and good conditions will find Pat ready to take advantage of them.

Sad to say, E. Parker (Hove) has had ill-health creep up on him, and worse, put paid to his R.A.E. studies. Ernie has some pointed remarks about people who QRM net operations by WAB, or whatever; it seems to him that twenty stations patiently waiting on one frequency can only reduce the QRM over the situation that would arise if they split up and took up twenty rag-chew channels. A good point—and an even better one when he says that most of the rag he hears being chewed on Eighty is only fit for the bonfire!

Like so many others, P. Barrett (Welwyn) has been inactive, R.A.E. revision taking priority, although he did find time to comb through old logs to find a few more prefixes. Talking of R.A.E., your old J.C. had a look at the paper and came to the conclusion that it was a lot fairer than those of recent years; anyone who went in properly prepared—and that is the crux of the matter—should have had no difficulty in passing provided he worked to his time schedule.

Another one to have been working seriously toward a ticket was J. Fitzgerald (Gt. Missenden), who will now be concentrating on CW listening to improve his speed, at least until the R.A.E. result comes out.

I. Brown (Newtownabbey, N.I.) has concentrated on 3.5 MHz since the start of the year, with a total score on the band of 111 countries since January 1. This is not to say Irwin has neglected the bands otherwise, as he has

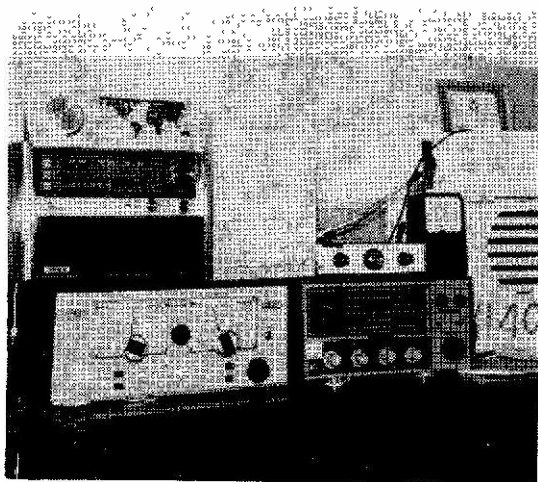

SWL station of M. Cornwall, Ivy Cottage, Newdigate Road, Harefield, Middlesex, who runs Codar and Heath receivers and is acquiring DX-heard totals.

loggings right up to two metres: for the latter, he has now an eight-element beam arranged for rotation by hand.

The letter from O. Cross (Bexleyheath) says he has bought a Yaesu FR-DX400S receiver, relegating the old 840A to the position of reserve. The new box seems to be finding plenty of new countries to add to the score, which now comes to 221 countries, 703 prefixes.

The short list from M. Williams (Sleaford) is mainly due to the absence of a receiver. That sound a reasonable conclusion to draw! Apparently, Maurice has persuaded one of the lads at the club to take on the overhaul of his AR88—yet another demonstration of the advantages of being a member of the local group.

On to D. Noakes (Cranbrook) who has been comparing the performance of his two-metre halo against the six-over-six, the halo being five feet the higher. Looking at the locals, on some signals there is little in it, and as far as DX goes, there are loggings of PA0 and F stations in one direction, and G's as far distant as Gloucestershire the other way. As Sam says, when one can get a converter so cheaply and get decent results from a halo, why should anyone be deterred from making a start with VHF?

Reverting to our comments last time round on the way to drive a receiver for SSB, H. Alford (Burnham-on-Sea) finds after four years of practice with his EA-12, he can obtain best results by careful manipulation of RF, IF and AF gain controls. True, when one has them—but with a simple receiver having a combined RF/IF gain control, the method advocated of using full AF and the RF/IF gain as a main control is at least basically correct—one can, with practice, find a more delicate balance of controls, but at least the method suggested last time will enable skill to be based on a sound basic technique.

W. J. Smith (Benfleet) heard a station giving its

callsign as "Kilowatt Denmark (figure missed) Table Mountain" and wonders what it could have been. In letters it would be KD?TM, which suggests it may have been some sort of special-activity station if indeed it were genuine. Has anyone else any details?

It seems we got things a bit wrong about the aerials owned by N. Henbrey (Northiam)—we turned his TA31 into a TA33. Norman's photographs—alas, not quite good enough to reproduce—show he has the eight-over-eight skeleton slot beam on Two, the TA-31 also rotatable with electrical rotation at the masthead, plus an 18-AVQ to cover 3.5—30 MHz—quite an aerial farm.

\* \* \*

M. Cornwall (Harefield) uses his letter to "grind an axe." As he so rightly says, Amateur Radio is not advertised enough, with the result that there are probably people about who would enjoy the hobby but don't know it even exists. True enough in a way; but one tends to feel that the sort of mind which has never heard of Amateur Radio is unlikely to make a good recruit. After all, it has been mentioned even in the women's magazines, let alone the odd reports in daily or local papers.

L. A. S. Poole (London N.21) has managed to find one of the numerous sources of interference, that due to a new gas central heating system installed next door. It seems that the makers have now, after tests by the GPO, installed a new control unit which has reduced the QRM to an occasional burp. However, he still has the electric lawnmowers, washing-machines, TV timebases and other electrical noises to contend with. As he is moving in the early part of next year. L.A.S.P. is holding fire for the moment on the question of installing his 14-AVQ vertical. In any case, he would like to know how one is meant to fit the 80m. loading coil—can anyone help him out?

Having a comb-out of the listings is always a good thing to do, and it nearly always reveals one or two prefixes as yet unclaimed, as the Bingham family from Carrickfergus have found.

Our suggestion that the drift in the receiver could be a function of the ventilation proved correct, says W. McFaul (Londonderry). Once the current crop of examinations are over, therefore, time will be taken to introduce some ventilation holes. We could add a comment that there should be a few holes in the chassis, too, to make sure that hot air is not trapped underneath even though there is provision for getting it away from the upper side.

There was a hiccup in the recording system at the shack of E. W. Robinson (Bury St. Edmunds) which knocked his total down by ten last time; however, a new method being used should avoid such problems in the future.

The loss of CW and SSB reception mentioned last time by J. H. Sparkes (Trowbridge) turned out to be caused by a dud 6BE6 valve which has now been replaced, thanks to the help of G6ACY/T. SWL Sparkes mentioned a joker on April 1, heard on Twenty signing "AP|RIL"

and taking in a fair number of stations. (This happens every year.—*Editor*.)

A spell in hospital with a chest ailment has rather limited the activity of A. Glass (Plymouth), but Bert still managed to add a few more prefixes to his CW list.

H. Londesborough (Swanland) has a bumper crop of prefixes to offer on Phone, and says he will shortly be sending in a first entry to the CW table—good.

Where is UA9WT, enquires H. M. Graham (Harefield). A look at the list published by Geoff Watts in his *DX News Sheet* some time ago suggests that he is in Bashkir oblast (county), in Zone 16. Maurice remarks on the number of FR-50B receivers about these days among the SWL fraternity, and says he likes the one he uses.

R. H. McVey (Weston-super-Mare) asks about the method of callsign allocation for reciprocal licensees. Broadly, there are two methods in use. The first one is to allocate a callsign in the normal run to the chap, such as for example giving an American a U.K. call—for example W4WFL holds G5AYL in this country. A variation on this is to make no distinction in the series and just to allocate as though the chap were a local native. The other system involves using his own callsign followed by a suffix consisting of the prefix letters of the country he is in, as for instance W4WFL/4X, who would be W4WFL operating in Israel, or G3KFE/W4 who would be operating a station in W4-land.

At D. Rodgers (Harwood) the object of the exercise, at least for the moment, is to keep up the Morse speed while waiting for the R.A.E. results this should be fairly easy, as Dennis is up to "twenties" already.

\* \* \*

P. L. Newman (Thame) is another of the hopeful band who wait for the R.A.E. results—he sent in his letter before the day of the exam. in case it demoralised him too much! On the aerial front there are beams for 144 and 432 MHz driven by the "handraulic" principle by judicious use of cable-and-pulleys. On a different tack, Paul wants to know if anyone has any idea about a suitable NBFM discriminator for 1.6 MHz IF. One possibility appears in the fourth edition of *Amateur Radio Techniques* on page 73; and there is another device worth looking into in the 1973 *ARRL Handbook* among the several shown on pages 430-434.

Although not taking the exam. this time, T. Rootsey (Ilford) has been preparing for the great day by getting together the needful bits and pieces, particularly in view of the onset of VAT. As a result he now listens on a KW-2000B, after taking the chance to try all the common sets at his local dealer—for whom, incidentally, Terry has nothing but praise. At a different point, we made a bit of a mess of his HPX score—how it happens escapes us—and unwittingly docked him a couple of hundred hard-won prefixes. However, unless the Law of Murphy strikes yet again, things should now be put to rights.

One of those who try to put in his hobby more than he takes out is R. Carter (Blackburn) who tries to keep up correspondence, by letter or tape, with people interested in radio but are unable to get out and about. Indeed, Ben's wife recognises most of the WAMRAC



tunable oscillator frequency and the BFO frequency, in the manner already done by one of the Heathkit accessories, one could obtain digital readout of the receiver frequency, using normal TTL for all save the first decade, which would need an HSTTL device, the mixing required being done in a couple of op-amps. There would be no need for a tuning capacitor, as the tunable oscillator could be handled by a varicap diode controlled by a potentiometer on the front panel. Controls could therefore be on the panel in the best ergonomic positions, with the digital readout so placed as to be easily visible at the operating position. The whole bag-o'-tricks would fit nicely in to a printed-circuit board, which could be etched easily enough at home by laying out the board and painting the parts to be retained with the XYL's nail-varnish, before etching in the conventional way. Thinking time and drawing time would not be impossible, but building time, and, most of all, metalworking time, could be reduced virtually to nothing.

How about someone thinking a bit harder along these lines—after all, between the FET's and IC's now on the market, it ought to be possible to build a receiver which can at least match, and probably better, the best of the current valve or transistor receivers, at all points, and at a economic price.

The main difficulty that is brought up is the problem

of getting the bits. This is greatly exaggerated. Quite a lot of firms, throughout the country, can and will supply the home-constructor market. Your scribe has bought one-off items, in the last few months, from various firms, never having to go more than a few miles either by post or in person.

#### Wind-up

This is where we mention the chaps who have only sent in score entries, perhaps covered by a brief note. Among these are: P. Barker, *Sunderland*; A West, *Herne Hill*, G. G. Proud and S. J. Proud, *Letterston*; R. Smye, *Shrewsbury*; R. Shilvock, *Lye*; S. Scott, *Stockport*; M. Hartley, *Preston*; T. Gravell, *Burry Port*; C. Henderson, *Beckenham*; G. W. Raven, *London, S.E.13*; M. Cuckoo, *Herne Bay*; B. F. Hughes, *Worcester*; W. B. Taunton, *Meopham*; M. J. Quintin, *Wotton-under-Edge*; and K. Williams, *Swinton*.

#### Conclusion

Now we have reached the other end of another pile of letters; all have yielded your scribe much satisfaction in reading, with their problems, their chuckles and whatever. For next time, the deadline is July 26 latest, addressed to "SWL," SHORT WAVE MAGAZINE, BUCKINGHAM, MK18 1RQ.

### \* \* \* THE MOBILE SCENE \* \* \*

#### REPORTS, PICTURES AND FIXTURES

For the Spalding Tulip-Fine Rally on May 6 they had a very large attendance (estimated at about 1,000) under Wx conditions much better than had been expected. More than 300 cars were parked by mid-afternoon. The marquee housing the nine trade stands was always crowded—other attractions were a CC/TV demonstration by the B.A.T.C. and a display of vintage wireless equipment.

One most interesting result was that recorded by the talk-in stations—G3MMS/P worked 35 mobiles on

two metres, but G3VPR/P was wanted by only 17 /M's on Top Band; there were also a few mobiles on 4m.

\* \* \*

Mrs. Frances Woolley, G3LWY, reports an excellent turn-out on May 20 at Romsey for the R.A.I.B.C. Picnic, a new event. Some 300 people came in, many more than expected, some from considerable distances, accompanying invalid or blind friends. The R.A.I.B.C. have the Southampton group to thank for laying on the meeting, providing talk-in, refreshment and such necessary background organisation, whereby a profit of over £50 was made for the R.A.I.B.C.



This fine ship is the Norwegian m.v. "Taimyr", LAVP, from which G5NX (Windermere, Westmorland) has been operating during a recent trip to the Far East. An ex-sea-going operator himself, G5NX has a special liaison with the LA authorities.



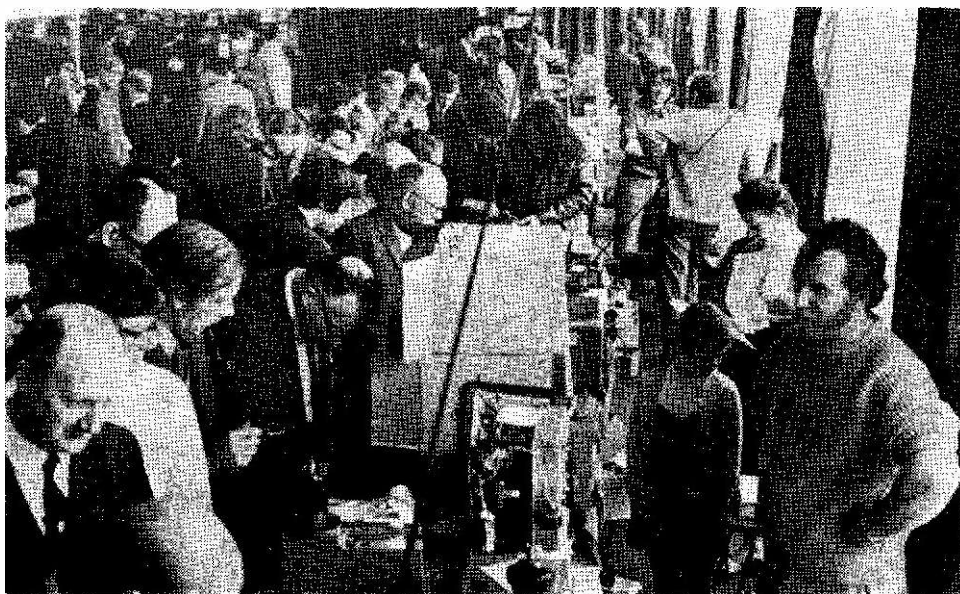

*Scene during the afternoon at the Northern Mobile Rally at Leeds*

We are told that the Northern Mobile Rally, Leeds, also taking place on May 20, was well attended, with good trade support.

\* \* \*

A change of venue has had to be made for the Wessex Mobile Rally on July 29. It will be at the School of Signals, Blandford, Dorset—other details as before.

#### THE RALLY CALENDAR

**July 1:** South Shields Mobile Rally, Redwell School, Prince Edward Road, A.1300, South Shields, the same as last year. There will be talk-in on Top Band and 145.8 MHz, trade stands, competitions, prize draw and refreshments on site, which is only half-a-mile from the coast.

**July 7-8:** At Lytchett Matravers, near Poole, Dorset, in conjunction with the Steam Rally & Fair, with talk-in on 145.00 (AM), 144.48 (FM) and 70.26 MHz (AM and FM).—A. G. Emery, G3YWG, 7 Brunel Drive, Preston, Weymouth, Dorset.

**July 8:** Worcester & District Amateur Radio Club annual Mobile Rally at Hill Secondary School, Upton-on-Severn, will include family attractions as well as trade stands, a model aircraft display and a stall for the disposal of unwanted gear. Talk-in will be by G8JC/A on 1910 kHz, and G3GJL/A on 145 MHz (AM and FM) also 145.41 MHz for SSB.—B. A. Jones, G8ASO, *QTHR*, or ring Worcester 0905 29208.

**July 8:** Cornish Mobile Rally at Treviglas School, Newquay, Cornwall, with trade stands, prize draw and various other attractions with the family in mind, also refreshments on site.—R. T. G. Tremelling, G3FWG, Finnartmore, Oakland Park, Falmouth, Cornwall.

**July 15:** Annual Mobile Rally organised by the Scarborough Amateur Radio Society at Burniston Road Barracks, Scarborough, as in previous years. Details: P. B. Briscoombe, G8KU, Roscaire, Irton, Scarborough, Yorkshire, YO12 4RL.

**July 29:** To be put on by the Wessex Amateur Radio Group at Royal School of Signals, Blandford Camp, Blandford, Dorset, with talk-in on 160/80/4/2 metres. Trade stands and refreshments.—A. G. Emery, G3YWG, 7 Brunel Drive, Preston (3177), Weymouth, Dorset.

**August 5:** RSGB Mobile Rally at Woburn Abbey, near Luton, Beds., as in previous years. Talk-in by GB3RS on 1910 and 3700 kHz, and by G3VHF on 70.26, 144.48 (FM), 145.00 (AM) and 145.41 MHz (SSB). There is a flat-rate charge of 50p for vehicles entering the Park, the bring-and-buy stall will charge 10% commission on sales, and the site is just off the A.50. There will be local sign-posting.—G. P. Shirville, G3VZV, 2 Orchard Close, Toddington, Dunstable, Beds.

**August 12:** Torbay annual Mobile Rally at Newton Abbot Rugby Club ground, with talk-in on 1867 kHz and two metres, the usual stands and com.



Seen at the Northern Mobile Rally at Leeds, left to right: G3WVD, G4JW, G8BZY and G8DFZ. This was a very successful Rally, organised by the Otley Radio Society.

petitions.—L. H. Webber, G3GDW, 43 Lime Tree Walk, Newton Abbot, Devon.

**August 12:** The 1973 Mobile Rally at Derby, organised by the Derby & District Amateur Radio Society, to be held at the Rykneld School in Bedford Street, as in previous years. Ample accommodation if wet, free entrance and plenty of parking space, many attractions for all comers. This is a well-established annual event, which regularly attracts a large attendance.—F. C. Ward, G2CVV, 5 Uplands Avenue, Littleover, Derby, DE3 7GE.

**August 19:** Preston (North Lancs.) Annual Mobile Rally at Kimberley Barracks, Deepdale Road, Preston, Lancs., with free car park, trade stalls, refreshments and a bring-and-buy offering. Talk-in will be given on Top Band and two metres.—Contact man G. W. Earnshaw, G3ZXC, 12 Withy Parade, Fulwood, Preston, Lancs., PR2 4JN.



Among those visiting the RAIBG Picnic at Romsey, Hants. on May 20, were, left to right: G2FIX, G3HRJ and old-timer Kenneth Alford, G2DX.

**August 26:** Stratford-on-Avon Radio Club Mobile Rally at the Town & Country Festival, National Agricultural Centre, Stoneleigh, Kenilworth, Warwickshire (on the A.444) one of the finest sites in England for an event of this sort, with attractions and activities too numerous to cover in this space. A consortium of Midlands radio amateur societies will organise an exhibition station and SWL display, and there will be a radio trade section, including GB3TCF to work visiting mobiles on Top Band or Two Metres. Information, including pamphlets and layout map, from: I. A. Cobbold, G3RPJ, 184 Loxley Road, Stratford-on-Avon, Warwickshire.

**September 23:** The annual Harlow & District Amateur Radio Society Rally will take place at Nettleswell School, Harlow, Essex, with ample indoor space available. There will be trade stands and the usual attractions at this regular event. Correspondence and trade enquiries to: V. Heard, 106 Vicarage Road, Harlow, Essex, CM20 3HQ.

**September 30:** Mobile Rally, opening at 11.0 a.m., at Walton School, Mountstevens Avenue, Walton being about four miles north of Peterborough city centre. Talk-in on Top Band and two metres by G3DQW, callsign of the Peterborough Radio & Electronics Society.—J. Chapman, 10 Bettles Close, Peterborough, Huntingdonshire.

We would be glad to have reports on these events, with photographs, from the organisers responsible. Address to: "Mobile Scene," SHORT WAVE MAGAZINE, BUCKINGHAM, MK18 1RQ.

#### MULLARD POWER TRANSISTORS

Mullard, Ltd. have produced a very interesting booklet bringing together a lot of information on the applications of their power transistors, with particular reference to SSB linear amplifiers. Five general designs are offered, ranging from a Class-A driver rated at 6w. p.e.p. to a 300w. Class-AB broad-banded RF amplifier, all these linears being intended for the range 1.6-30 MHz. The transistors used are the 2N3632, BLX13, 810BLY/A, BLX14 and, for the 300-watt amplifier, a pair of BLX15's, an n.p.n. silicon-planar type operating at 50v. on the line. The design data are very complete and useful notes on construction are also included.

*Transistors for Single-Sideband Linear Amplifiers*, TP1337, Mullard, Ltd., Mullard House, Torrington Place, London, WC1E 7HD.

To keep in touch with the world of Amateur Radio, read "Short Wave Magazine" regularly —  
Independent, Unsubsidised and now in its 31st volume.

### Airborne Transponders

THE two French transponders launched on May 20 and May 31 respectively were a considerable success. The first, with the callsign *Mirabelle*, reached a height of 25,000 metres after the launch from Nancy, and was finally retrieved at Sully-sur-Nied (Moselle) from the top of a high tree. Contacts were made with OE, DL, ON, HB, G and PA. (F9FT had a total of 77 QSO's *via* the transponder!). G8CCH (Basingstoke) first heard the beacon on two metres at 1510z and the last signals were received at about 1700z. He logged 17 DL, eight F, two PA and one each OE (OE20ML) and G (G3LQR). Most signals were at 5 & 9 and all on SSB with the exception of F3YM/P, who was on AM. Heard, but not identified, were SS/TV burbles at 1552z. Fading was negligible, and Andrew reckons this must be just about the easiest way of working six countries on 70 cm. that he has come across. G8CFZ reports good reception of the beacons on 145.2 MHz and 145.8 MHz although he only made two contacts due to his poor antenna heading.

Details of the flight times of the second transponder, *Anjou 3*, are not yet to hand, but this also seems to have been a most successful happening. Launch was from Angers (ZH48h) with a beacon on 145.9 MHz and transmission between 145.45 MHz and 145.75 MHz and reception between 432.35 MHz and 432.65 MHz. Transmit power was 1.5 watts. G8CCH again reports logging many French and German stations, mostly on SSB, and gives arrival as 0850z and loss at 1033z. G8CFZ found conditions a little better on this occasion and had a total of 18 French contacts. G3COJ was unable to be on for the whole flight, but sent in an impressive list of stations worked, with the best DX as F8CH/P in Toulouse. He comments, also, on the preponderance of SSB signals, although most of his contacts were on AM.

The reports from Mike Walters, G3JVL are very comprehensive. Unfortunately, space does not permit inclusion here in their entirety, but the following extracts give an idea of the performance as logged in Hayling Island. *Mirabelle*: The beacon on 145.2 MHz was first

# VHF BANDS

A. H. DORMER—G3DAH

heard at 5 & 7 at 1458z, rising to S9 by 1510z. Some 30 different stations were heard, including OE3UXA, although Mike was unable to get in due to his very low power at the time. He notes that the best signals were very much stronger than those from *Oscar VI*, and that the use of excessive power reduced signal strengths in a similar manner to that experienced with the satellite. *Anjou*: The beacon signal on 145.9 MHz was first logged at 0844z at 5 & 7, and the first station heard was F2RP calling CQ at 0848z, RST 579, followed by F9FT at RST 599. At this time, Mike was copying his own translated signal (one watt RF to an 8-ele Parabeam) which finally faded out at 1020z, although the beacon was still audible until 1040z.

Future launches are scheduled for July 4, July 29, August 26 and September 23 (or October 22) and we shall endeavour to give you plenty of advance warning with more detail nearer the time.

### Beacons & Repeaters

It is reported from GM that the 2m. beacon GB3ANG is operating at reduced strength, and that the fall in e.r.p. coincided with the thunderstorms of May 27, the two events possibly being connected. GB3SX appeared again for about an hour on June 2, but without any keying. It signed off on CW at 2345z. The signal was very variable in strength throughout the transmission. Signal strength from GB3VHF has also been variable

recently—even at close range.

ZB2VHF is in the news again, and several reports of reception have come to hand. G3ZRH in Brentwood copied the signal first on May 10 and G5DF (Reading) and G3DOR (Staines) both heard it on May 27. According to G3ZRH the frequency is 70.264 MHz. G3OHH (Mow Cop) received it at 599.579 between 1810z and 1820z on May 29 and noted that there were no breaks between callsigns. G8PY (Nottingham) was getting an S9 signal from 1730z to 1815z on May 30 and G3SMU (Manchester) noted that the keying was faulty and the note chirpy at 1800z on June 1. There was some difficulty in getting a bearing on it—not uncommon with Sporadic-E. G4BDW (Oxon) copied the beacon at 589 on May 24. 27 and 29 using a Pye Vanguard with a  $\frac{1}{4}$ -wave whip! He reports that the beacon keeper is now ZB2BL, who would like to have reports *via* PO Box 292, Gibraltar.

An Austrian translator has been set up near Salzburg with the callsign OE2XSO. Input frequency is 432.0 MHz and output 145.6 MHz. Radiated power is 20 watts, so this could be on from the U.K. during an opening.

Several Swiss translators are now in operation: HB9Z (Vetliberg), HB9B (Basle), HB9AA (Pilatus), HB9FG (Chaumont), all operating with input on 431.05 MHz and output on 438.65 MHz, also HB9CC (Santis) and HB9BA (Weissenstein) with input on 431.2 and output on 438.8 MHz. Other repeaters are in operation on channel R74, *i.e.* 431.15 MHz input and 438.75 MHz output.

News has just arrived that G3ZRH (Brentwood, Essex) worked ZB2VHF at 1345z on June 9. He is the first station to have made contact with Gibraltar this year—on 4m. that is. Gear at ZB2 is an FT-101 with a two-element horizontal antenna. Operation is automatic on weekdays and manual at weekends.

ZC4VHF is now operating on 50.5 MHz beaming towards the U.K. and has been heard by G4BEG (Walton-on-Thames) on a four-metre beam.

### Oscar VI

*Oscar* continues to survive in spite of the power, temperature and

switching problems. The latest reports from AMSAT give the following parameters: Orbital time 114-9946 minutes: Orbital shift 28-7484°W. Reports on the behaviour of the *Oscar* signal during the solar eclipse on June 30 will be of particular interest—see p.237, June. Although the eclipse will not be much over this country, the partial effect should be visible in the South from 1102z till 1128z, maximum shadowing occurring at a sun altitude of 61° and azimuth of 158° at 1119z. No *Oscar* pass within range of the UK occurs between these times, but, as the Table shows, Pass No. 3228 crosses 52°N just after the event and should be worth watching.

*Reports on Oscar:* Bob Holmes, G6RH, has now worked a total of 52 different prefixes, calculated on the basis outlined in last month's "VHF Bands," and has had 640 contacts of which 104 have been trans-Atlantic, a pretty impressive result. He is still using the inverted dipole for 10m. reception, and has just completed a solid-state Rx using IC's to go with it.

G3NHE (Sheffield) has made it with 42 prefixes and a total number of 502 QSO's, while Dewi Davies, GW3FSP (Bridgend) has now had 1,000+ contacts of which 400+ arc across the Pond! Mike Walters, G3JVL, has booked in 570 contacts with 182 different stations in 33 countries, acquiring 40 prefixes. He is one of the few who have

ever heard, let alone worked, W5 via *Oscar*.

Regular observers will certainly know the callsign F9FT. Working with Marc the other evening he reported that he had by then had 3,462 QSO's with 450 different stations in 41 countries, of which 233 were trans-Atlantic—including W5! He has worked K2GUG, another regular, no less than 40 times.

From AMSAT reports of the analysis of the first six weeks of operation of *Oscar VI*, it is noted that about two-thirds of the contacts were on CW, just over a quarter on SSB and the remainder a mixture of the two modes.

#### VHFCC Awards

First award this month, No. 188, goes to Geoff Spencer, GW8FOL, Anglesey, and we are very pleased to welcome another GW aboard—we don't have many GW claims, possibly because the terrain is often pretty difficult for VHF/UHF. Most of the contacts in this claim were made on AM with 13 watts to a QQVO3-10, but recently acquired is the FT-200 and a transverter driving a QQVO6-40A with 120 watts p.c.p. input feeding a 10-ele. at 60ft. The receive converter is a BF180 RF amplifier and 40602 mixer. Plans for the future include 70 cm. gear, an improved antenna system for 2m. and a linear with a pair of 4X150A's—which should

put his rare county within the reach of many.

Award No. 189 is for Colin Baker, G8GMR (Luton) for two metres. He became interested in 1965 and passed the R.A.E. in 1968, but a long spell in hospital after a road accident prevented him from getting on the air, and it was not until 1972 that he got his ticket. (He mentions how grateful he is to the Dunstable Downs Radio Club, not only for fixing him up with a Tx/Rx while he was in hospital, but also helped him greatly with setting up the gear at the home QTH once he was able to get about again). Present outfit is a *Microwave Modules* two-watt driver with PA giving 20 watts of RF for the 14/14 antenna at a mean height of 70ft. on a 530ft. a.s.l. site. Two converters are in use, one with an FET (40673) mixer and the other a *Burns Electronics* job with HP2811 diodes. Main Rx is the GEC RC410/R, but an RA-1 is also available.

We say again, and this point crops up at least once a month, that claims for the VHF Tables and for VHFCC *must* be for QSO's made from a *fixed* location. /P and /M contacts are *not* admissible as additives. But callsign changes from G8/3 to G4/3 are acceptable.

#### The Caledonian Vista

Graham Knight, GM8FFX, found conditions good for the 2m. Portable Contest on May 26. He was on

The well-known Ae. manufacturing firm of J-Beam Engineering, Ltd., of Northampton, can now offer a vertically-polarised GP antenna for the two-metre band. Its 61 ohms input impedance will match nicely into 50 or 75 ohm coax with a low VSWR and the polar diagram, which is truly omnidirectional in the horizontal plane, will give better home-station communication with the whip aerials now being popularly used by two-metre /M's. The price is about £3.50 when VAT is taken at 10%.

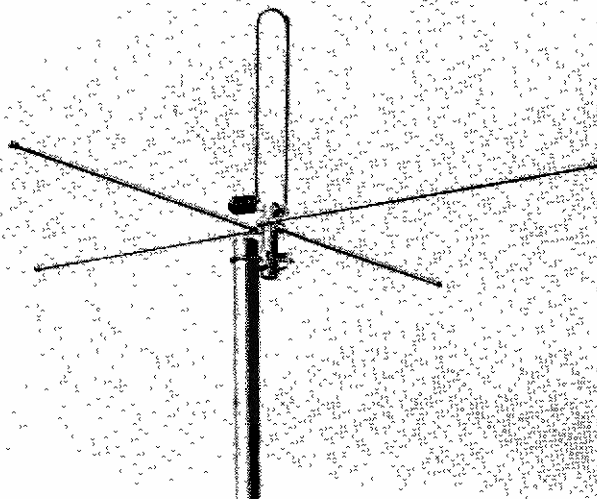

from Kincardineshire and had 83 contacts, with best DX as G8AGU/P in Devon. Others active at this time were GM3ZBE from Aberdeenshire and GM8AOB in Banffshire, to say nothing of a visitor, GM3BA/P, in Wigtown. Incidentally, GM8AOB is now two-metre working in Burghhead, Morayshire, and will be active on SSB from there and from Banffshire, both places much sought after by the county-chasers. Also out for the day, were GM3OWU, GM3KJF, GM3ZVB, GM3SAN and GM3BQA (who was putting out a very nice signal to the South from the Lammermuir Hills). A newcomer in the North-East is GM8GHV (Dyce). GM8FFX will be portable in the Isle of Man again for the 2m. SSB contest on August 19 and will shortly have higher 70 cm. power.

SSB operation continues to flourish in GM, two recent converts being GM8FM and GM8DKB. GM8BKE now has SSB on both 2m. and 70 cm. and hammered a few front ends when he operated mobile on 70 cm. with that mode from a well-known site near Edinburgh. GM8BJF is still beavering away on the construction of his 2m. transceiver and GM3OWU hopes to join the SSB ranks shortly with a transceiver.

## About The VHF Spectra

GM3TNT in Argyllshire reports reception of the ZB2VHF *Gibraltar* beacon on 4m., at S9 on occasions; that's a fair old haul! GM8GEL is a comparative newcomer to 2m. and runs a mere 80 milliwatts to a 3-ele. indoor Yagi, but nevertheless got an S9 report from a portable on the summit of Ben Nevis, which is not a bad beginning! GM8HEY, following the Dunfermline tradition, is putting out an excellent 2m. signal these days.

GM6XI had many good wishes for his survival after the note last month that he had now reached the three-score-years-and-ten-mark, but in an endeavour to ensure it, he reports that he has had to change the halo on the car for a whip after having been nearly pranged on three occasions by drivers whose attention was fixed more on the aerial than on the road!

GM3BQA is now running a Parabeam at 70ft. and an 8/8 slot at 80ft. This set-up, with a transverter and the FT-101, helps to

explain the ease with which he seems to be able to make G contacts.

### DX-Peditions

The North Bucks. group will be coming up as GD4AFN/P during the 432 MHz contest on July 22, and will stay on in the Island until August 3. They will have SSB, AM and NBFM on 2m. and AM and NBFM on 70 cm. Skeds via G8FIK, *QTHR* (with s.a.e. pse.) and further details from G8AAT, *QTHR*.

The Blackwood Club trip to some of the rare Welsh counties during the second week in August was mentioned in May "VHF Bands," and further details are now to hand. Two-metre equipment will give 30 watts of AM/CW and it is anticipated that 200 watts of SSB will also be available. They will have a low-power SSB rig for anyone interested in the WAB Award, and a "black box" with all the usual FM channels. The antenna is an 8-ele. Yagi. Participants are GW3WTZ, GW4BLE, GW8FXM and SWL Rees, and the callsign will be GW6GW/P. Counties to be visited are still to be announced.

G3ZUL and G8ACB will be operating from Wales as follows: July 17, *Montgomery*; 18, *Cardigan*; 19, *Pembroke*; 20, *Carmarthen*; 21, *Monmouth* and 22, *Brecon*. Frequencies are 432.36 MHz and 145.6 MHz—AM and CW on 70 cm. and AM and SSB on two metres. They hope to have 23 cm. gear with them, and if this materialises that QRG will be 1297.08 MHz. Callsign is GW3ZUL/P on 70 cm. and 23 cm. and GW8ACB/P on 2m. Operating times 1800z to 2100+z, band according to conditions. Requests for skeds, stating mode, frequency and power output to G3ZUL, *QTHR*.

### Contests

*Results:* We congratulate G3VIZ/A and G3MOT as winner and runner-up respectively of the March 144 MHz fixed station contest. In parallel with this event was the 144/432 MHz Open, won by

### OSCAR VI — Prediction Data

Orbit	Date	Time	Position	Direction
3226	June 30	0802	27°E	N/S
3227		0957	02°W	N/S
3228		1152	30°W	N/S
3231		1713	39°E	S/N
3232	July 1	1908	11°E	S/N
3233		2103	18°W	S/N
3238		0702	42°E	N/S
3239		0857	13°E	N/S
3240		1052	15°W	N/S
3241		1247	44°W	N/S
3244		1808	26°E	S/N
3245		2003	03°W	S/N
3246	July 14	2158	32°W	S/N
3401		0726	36°E	N/S
3402		0921	07°E	N/S
3403		1116	21°W	N/S
3407	Jul 15	1832	20°E	S/N
3408		2027	09°W	S/N
3409		2222	38°W	S/N
3414		0821	22°E	N/S
3415		1016	06°W	N/S
3416		1211	35°W	N/S
3419		1732	35°E	S/N
3420		1927	06°E	S/N
3421	2122	23°W	S/N	

Times shown are for crossings at 52 N. Orbits beyond 45°E or W are not included. To calculate later orbits, deduct 5.15 minutes and add 1.29°E each 25 orbits. Orbits shown are for weekend operations only in view of the revised AMSAT procedure. Time in GMT. East/west positions in degrees relative to Greenwich, 0°.

## THREE BAND ANNUAL VHF TABLE

January to December, 1973

Station	FOUR METRES		TWO METRES		70 CENTIMETRES		TOTAL Points
	Counties	Countries	Counties	Countries	Counties	Countries	
GD2HDZ	19	3	60	8	17	4	111
G4BEL	8	2	54	11	29	4	108
G3NHE	13	3	51	11	25	3	106
G3OHH	45	6	37	5	8	2	103
G3FIJ	27	3	38	6	15	1	90
G8FU1	—	—	59	9	17	2	87
G8EOP	—	—	50	8	27	2	87
G3DAH	28	3	40	8	5	1	85
GW8FOL	—	—	62	8	—	—	70
G8DNK	—	—	59	10	—	—	69
G2AXI	20	2	33	3	6	1	65
G8FMK	—	—	38	2	23	1	64
G8BXX	—	—	40	7	15	1	63
GW3ZTH	—	—	53	9	—	—	62
G8GNE	—	—	42	5	12	1	60
G4BMM	7	1	34	5	12	1	60
G8CKZ	—	—	45	9	—	—	54
GM3ZVB	1	1	42	8	—	—	52
G3XDY	—	—	44	8	—	—	52
GW8FKB	—	—	45	7	—	—	52
G8FQE	—	—	45	7	—	—	52
G3BW	—	—	43	8	—	—	51
G4ASR	—	—	47	2	—	—	49
G4BKG	—	—	40	7	—	—	47
G3SMU	12	3	10	2	16	3	46
GM3ZVL	—	—	34	7	4	1	46
GW8DUP	—	—	38	7	—	—	45
G4AFQ	—	—	25	2	13	3	43
G8CBU	—	—	32	3	6	1	42
G4AJE	—	—	32	6	2	1	41
G8DGR	—	—	32	2	6	1	41
G8BKR	—	—	30	3	6	2	41
GW8EHK	—	—	28	7	—	—	35
G8GPR	—	—	30	4	—	—	34
G18EWM	—	—	26	5	—	—	31
G8GNC	—	—	28	2	—	—	30
G8DOT	—	—	25	5	—	—	30
G8COG	—	—	23	3	—	—	26
G8EMS	—	—	20	2	2	1	25
G8GBV	—	—	16	3	5	1	25
G8GJB	—	—	21	3	—	—	24
G4AEZ	—	—	22	1	—	—	23
G8ECU	—	—	19	2	—	—	21
G3EKP	8	3	4	2	2	2	21
G3WHK	—	—	17	3	—	—	20
G8FUL	—	—	18	2	—	—	20
G4BOW	—	—	16	2	—	—	18
GW8CMA	—	—	14	3	—	—	17
G3CBY	—	—	11	5	—	—	16
G8GXE	—	—	14	1	—	—	15
GW8CGH	—	—	7	2	—	—	9

The Table shows claims to date from January 1 1973 and runs through to December 31st, 1973. Your claims should be sent to:—"VHF Bands," Short Wave Magazine, Buckingham, MK18 1RQ each month.

GW3ERP/P in Denbyshire followed by G4BEL in Cambs. The 432 MHz Open over the weekend of April 1 brought victory to Arthur Russell, operating in Derbyshire as G8AWS/P, and Roger Taylor, G4BEL was once again the runner-up.

The Mid-Severn Valley RTTY contest on May 13 attracted nine entries and was won by GW4AYK/P in Brecon, who seems to have coped quite nicely with the extraordinary situation where the South-East was on 49 bauds and the Midlands on 50 bauds. It is time this anomaly was resolved, surely?

*Reports:* Early comments on the contests of May 5/6 were included last month. As a follow-up to these, it is learned from GW8FOL that, although 2m. conditions were poor with him in Anglesey, he noted an increase in activity from G1 with G13WTC, G14CBW, G18EWM and G13EPG all good signals. But, he asks, where have all the EI's gone? Only one has been heard this year, and that in spite of the fact that it is only some 60 miles across the sea from Eire. Most correspondents report the difficulty of making DX contacts on 70 cm. at this time, G3UBX (Wolverhampton) in particular, remarking that he finished with 42 points only and that, although he made it with GW3UCB in Anglesey on 2m., a QSY to 70 cm. produced no result, a QSO which would just have doubled his score!

Propagation seems to have been reasonably good for the 144 MHz portable contest on May 27. Many operators report good reception of the GM people, GM3BA/P in Wigtown, GM8FFX/P on Cairn o' Mounth and GM8BJF/P in Lanarkshire in particular. G8AGU/P in Devon provided some nice DX for the Northern Midlanders as did G3JXN in London, who was 5 & 9 for much of the time in the North West. G8GXE and G8ETB were operating in Bucks. and also found conditions good for North/South contacts. They were only running 5 watts, but finished up with 60 contacts in 28 counties and 2 countries, best DX being with G8FTZ in Co. Durham. Gotaways were GD2HDZ, GM3BQA and F1CCP GW8EHK did not reckon conditions to be too good, but

For the Northern Mobile Rally at Leeds on May 20, the two-metre talk-in was provided by G8AWN/A with this neat set-up.

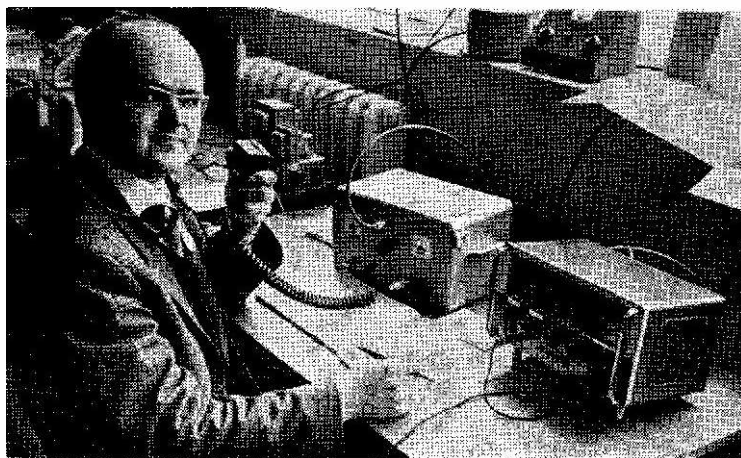

nevertheless he made it with GM3BA/P and GM3BHT/P. GI8EWM in Co. Antrim made it with plenty of Northern G, GW and Southern GM stations, but could not raise anyone in the Midlands although he was hearing G3OSS in London at 5 & 4. He expects to be operating from one of the rarer GI counties during the July 7/8 contest and should have some fairly high power SSB available in addition to the AM. Known to be active were GI8AYZ/P and GC8EZA/P (Jersey) for a couple of good DX contacts. Best score heard towards the end of the contest was that of G3OBD/P (Brecon) with 150 QSO's completed.

Conditions for the four-metre event on June 9/10 were variable, but better than might have been expected in view of recent poor propagation (excluding Sporadic-E) on the band. Good DX in the shape of GI and GM was to be had for brief periods. Scores around the 100 mark were typical of the leaders, indicating but an average level of activity. Such as there was seemed to be shared equally between AM and CW with very little NBFM or SSB. Among the Welsh portables, GW4ABR near Newtown in Montgomery and GM4KF/P (Usk) provided consistently good signals and GW3UCB/P in Anglesey was spasmodically well received in the South. An outstanding signal from Wales was that of GW3MHW in Montgomery—not a callsign particularly well-known on 4m. in much of the country, but one which is likely

to become so, one would opine. Stations in the South were heard calling EI/GI without result. GM3WOJ/P in Peebleshire (Broadlaw?) was called and worked by many Southerners. Procedures were good, although operators on this band have far to go to match 2m. for co-channel and VFO/VXO working.

*Forthcoming Events:* Ainsdale Radio Club are organising the Region I VHF contest again this year. Date is Sunday, August 5 from 0900z to 1800z on 4m., 2m. and 70 cm. Entries from operators outside the Region are welcome, and a special "Outside Section" has been set up for them. Further data and completed logs from and to Norman Horrocks, G2CUZ, *QTHR*.

July 7/8 for the RSGB Jubilee VHF/UHF event and July 22 for the 432 MHz portable.

#### News Items

*Four Metres:* A newcomer on 4m. who is putting out a good signal is G4BGZ in Leicester. He runs a QQVO3-10 PA into a 4-ele. at 30ft. and although he enthuses about the activity on the band at weekends, he is disappointed by the lack of it during the week. Aren't we all?

Mike Gibbings, G3FDW (Retford, Notts.) has raised his all-time 4m. score to 73 counties and has worked 16 of them on 2-way SSB. As he says, it has only taken him 10 years to get that far! Incidentally, what a good signal he was during the last 4m. contest while operating /P from Co. Durham.

*Two Metres:* The TVI troubles at GD2HDZ have been cleared with the help of the local P.O. engineer and Arthur is back in full operation again. G8EOP reports that G3YRM in Northumberland is QRV with SSB, as is G3ZJY in Co. Durham. The G8EOP / G8DNK / G8BCL / DC9KU skeds on 145-350 MHz at 2100z daily have resulted in 100% success to date. Breakers with good manners are welcome to join in! G4BKG (Tunbridge Wells) is now active on SSB with a "Liner 2".

G3WW reports an SS/TV 2-way QSO on 2m. when he exchanged video with G8DXC over a 10-mile path on the morning of May 21 last. He hopes that this may encourage others to try this mode on 144 MHz.

*Seventy Cm:* G8GBV draws attention to a new form of the TVI menace which is likely to become more troublesome. He has found that his 70 cm. signals can get into the front end of some of the newer UHF TV sets which are varicap tuned, there they are rectified, and the resultant DC alters the varicap bias and hence the tuning of the RX. Nasty, but the usual filter remedies should get rid of it.

G3DAH hopes to be back on 70 cm. for the next contest.

#### General

G4ASR is now operating on 4m., 2m. and 70 cm. from a new QTH near North Weald. The site is 364 ft. a.s.l., which may partly account for his big signal. He

runs 22 watts out to a 4-ele. Yagi on 4m., 25 watts to a 12/12 on 2m. and either 10 watts input or 70 watts output (from a 4CX250B) on 70 cm.

G8CIW, commenting further about the note last month on the long-distance mobile contact between G8EYO/M and G3NHE, reports another which involved himself out portable in Epsom, Surrey, and G8EYO/M again. This time, the contact was maintained from Pontefract, Yorks. to Epsom, Surrey, a distance of about 180 miles with signal strengths ranging from 5 dB to 20 dB above noise. 'EYO had a "Liner 2" with a pre-amp and a 4-ele. beam about 4ft. above the top of his van, and 'CIW was running a Braun SE600 and 10-ele. beam at 20ft. A notable feature of this solid

QSO was the absence of annoying mobile flutter—another advantage of this mode for mobile operation. The disadvantage is, of course, that mobile-to-mobile contacts will be few until more SSB equipment is fitted to vehicles.

G8CBU and G3YV1 impressed Sir William Gladstone, the Chief Scout, when they set up a 2m. station at Amphil Park during the latter's visit. They worked 75 stations all told with a Pye Cambridge and a 6/6 slot, and had some 300 visitors to the shack.

G3KDL made the round trip from Wembley to take in both the Belgian VHF/UHF Convention in Brussels and the RAIBC picnic at Romsey. Although he was not there for the latter event, your

scribe has attended the former, and can recommend the trip, although a wary eye must be kept open, as the hospitality of the ON amateurs can be quite staggering in every sense of the word!

The new *Burns Electronics* components catalogue is now available, and lists many "goodies" at reasonable prices. With components becoming more and more difficult to obtain, this publication is a very useful addition to the library.

#### Deadline

Deadline for the next issue is July 6. The address for news, views and comment is:—"VHF Bands," SHORT WAVE MAGAZINE, BUCKINGHAM, MK18 1RQ.

Cheers for now and 73 de G3DAH

#### MONITORING I.C. PIN VOLTAGES

**O**FTEN the hardest part of getting IC equipment to work is when it comes to trying either to measure the voltage on a particular pin or to fix an oscilloscope probe to a pin of a dual in-line package.

Trying to use crocodile clips or test probes usually results in them either shorting adjacent pins or falling off completely (and dropping on to some other part of the circuit where they usually wreak some form of havoc).

After a number of IC's had met their end in this way it was decided that some simple tool should be made up to solve the problem.

The device was made by taking a DIL holder and giving each pin a 90° twist with a pair of pliers so that it can then be plugged into another DIL holder (the one containing the IC under test). An insulated wire is then carefully soldered to each pin as near to the holder as possible and using as fine a wire as is practicable. These wires are then brought out to a small plastic box with 14 or 16 sockets on its lid which are numbered to correspond to the pins of the holder.

When the device is in use the IC to be tested is simply removed from its holder, plugged into the test holder which is in turn inserted into the IC normal holder. Pins can then be monitored without the danger of shorting anything out.

Since building this little device it has not only proved useful for the purpose for which it was originally designed but also for cut-and-try work, enabling a component to be tried in place without the inconvenience of soldering.

K.C.W.

#### NAME AND ADDRESS, PSE!

We are anxious to get in touch with the holder of G3AUS, name and address unknown and not listed in any call-book. If he will make himself known to us, he will "hear of something to his advantage," as the saying is.

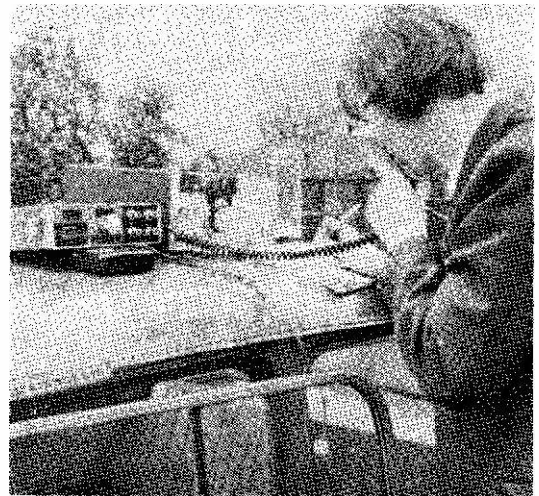

For the two-metre contest on May 27, G18EWM/P ran a Liner-2 and a JR-599. His final score was 263 points from 35 QSO's—"not sufficient to warrant an entry," as he puts it. Pity!



# THE MONTH WITH THE CLUBS

By "Club Secretary"

(Deadline for August issue: July 5)

(Please address all reports for this feature to "Club Secretary", SHORT WAVE MAGAZINE, Buckingham.)

AT this time of the year, when Test cricket, the garden, holidays, summer weather, all are competing with the attractions offered at a Club meeting, the programme should have something special to offer if attendances are to be maintained. Just what "that something" should be depends largely on the nature of the group—some go for competitive activities such as Field Day, or portable expeditions, whereas other Clubs are utterly non-competitive and would stay right away from outdoor portable activities. For the latter, a visit to somewhere of interest, such as a mobile rally, or an "extra-special" lecture may be the prescription. Of course, another way of dealing with the problem is accepted by many groups, and that is just to have no meetings during August while holidays are depleting the usual attendance.

Now we must get on with the mail, taking it as usual in a "territorial" fashion and looking first at the national organisations.

First on this clip is the Royal Navy who get together by way of nets on the one hand, and their consistently good *Newsletter* on the other, containing news of members in all parts of the world, articles, jokes, and all sorts of interesting items.

A.R.M.S. is the crowd to be with if you have an interest in the mobile facet of Amateur Radio, whatever band you operate from Top Band to UHF, as transmitter or as SWL. The group organises a Mobile Rally, has a monthly newsletter, *Mobile News*, and offers some very useful services to members.

The full members of R.A.I.B.C. are all either invalids or blind, while the objects of the Club are in the main sustained for by the "supporter" members. The latter function could include anything from helping to get an aerial up for someone, through technical help, to just being ready to transport the odd item for somebody in the group in the course of one's normal running around in the car. All the details can be obtained by writing to G3LWY, address as in the Panel p.304.

Now a truly National Society, in the shape of the Nigerian. From their newsletter we hear of the doings of all the 5N2's, and of the frustrating lack of progress in obtaining the release of some new licences to those who are waiting. Let us hope the long-for issue will take place soon.

## The Midlands

Might loosely be defined as the frontier area between the North and the South.

Our first port of call is **Kettering**, where the old group that used to exist prior to 1939 has been reformed, interestingly enough with the same Secretary (SWL) as took the duty in those distant days, and with another member of the pre-War group taking office as chairman. As to the pattern of events, it is not possible at this time to be specific about talks, but it is known that the lads foregather on the second Wednesday of each month at the Youth Centre, School Lane, Kettering. If you are intending to visit them, or to join, we suggest you first get in touch with the Secretary (as Panel), as they are very actively pursuing the goal of a place of their own where a shack can contain the gear for their own old G5KN call.

The dates for July at **Slade** are Fridays 13th and 27th, and their Hq. is at the Committee Room, Church House, High Street, Erdington.

Not far away is **Wolverhampton**, where there is a full programme; Morse classes appear each week, on July 6, 13, 20, and 27, at Hq. Then on July 2 there is a tape lecture—"An Anthology of Radio Signals"—and Natter sessions on July 9 and 30. July 23 is a committee meeting, and on July 16 comes the Junk Sale, with, as usual, a 10% "cut" for Club funds. The venue is Neachells Cottage, Stockwell End, Tettenhall, Wolverhampton.

**South Manchester** are another lot of busy bees; the VHF element get together at Grceba, Shady Lane, Manchester 23, every Monday, while the main event is on Fridays at Sale Moor Community Centre, Norris Road, Sale. July 6 sees them off on a visit, while July 13 is set aside for G4BJT to talk about and experiment with an RF Noise Bridge, showing its value in Aerial investigation work. July 20 is also an "away," this time at the Manchester Flower Show, Platt Fields, Manchester, where they are to have a station set up. Finally, July 27, and the competitive types will be giving keen ear to G8DMJ, when he talks about the preparations and operation in VHF Contests.

For **Midland** the attraction on July 17 is a talk by Bob Palmer, G5PP, on "Chassis-Bashing"—at the usual venue, namely the Midland Institute in Margaret Street,

Birmingham, 3. Incidentally, secretary G8BHE writes that he thoroughly enjoyed the North Midlands Mobile Rally, which was a joint venture by the Stoke and Midland groups.

Coventry will keep things simple during July; on 6th, 20th and 27th, they will be at Baden-Powell House, St. Nicholas Street, Radford Road, with the Club rig fired up on the bands. As for July 20, on that date the chaps get out their gear for a visit to Coventry Swimming baths(!).

The Swan Hotel, Bird Street, is the Hq. of the Lichfield chaps, who get together there on July 2 and July 17, at 8.15 p.m. The first date is down for G3WPB to talk about "Test Instruments and their Uses around the Shack," and on the 17th there is a Junk Sale. As an extra diversion on Sunday, July 1, there is a D/F competition.

Wirral are still at their temporary Hq. at the Com-

munity Centre, Carr Bridge Road, Woodchurdh, the entrance to which is through the large doors on the left side of the building. July 4 is "to be arranged," while on July 18, G3YGL will be talking about Servicing Tricks. In between, over the weekend July 7-8, there will be a weekend DX-pedition, for which one hopes the weather will be kinder than it was last time!

### Northwards

Here our first port of call is at Derby, where the venue is normally 119 Green Lane, Derby. Additions and alterations to the advertised programme are put out on Sunday mornings on GB2RS, and also mentioned by Radio Derby on 96.5 MHz, not counting any detail given out at meetings or stuck up on the Club notice board. No one has any excuse for missing out on anything! In general, Mondays are "Project Nights" when the lads make-do and mend the Club equipment and

### Names and Addresses of Club Secretaries reporting in this issue :

ACTON, BRENTFORD & CHISWICK: W. G. Dyer, G3GEH, 188 Gunnersbury Avenue, Acton, London, W3-8LB.  
A.R.M.S.: N. A. S. Fitch, G3FPK, 40 Eskdale Gardens, Purley, Surrey, CR2-1EZ.  
BASINGSTOKE: R. Oakley, G8FKT, 81 Camrose Way, Basingstoke.  
BEDFORD: J. Bennett, G3FWA, 47 Ibbett Close, Kempston (2427), Bedford.  
BISHOPS STORTFORD: E. P. Essery, G3KFE, 17 Ascot Close, Parsonage Lane, Bishops Stortford (52501), CM23-5BP.  
BOLTON: S. MacDonald, G4AQB, 8 Archer Avenue, Bolton (20668), BL2-2SJ.  
CHILTERN: F. Rose, G2DRT, 84 Cock Lane, High Wycombe, Bucks. (Penn 4240).  
CORNISH: H. Webster, G3XTF, Crandale, Gillyfields, Redruth (6903).  
COVENTRY: G. A. Whenham, G3TFA, Lavernock, 33 Chapel Street, Bishops Itchington, Warwickshire.  
CRAY VALLEY: P. F. Vella, G3WVF, 78 Hurst Road, Sidcup, Kent.  
CRYSTAL PALACE: G. M. C. Stone, G3FZL, 11 Liphook Crescent, London, S.E.23-3BN. (01-699 6940).  
DERBY: F. C. Ward, G2CVV, 5 Uplands Avenue, Littleover, Derby (21931), DE3-7GE.  
DERBY (Nunfield): I. Cage, G8GBV, 25 Petersham Drive, Alvaston, Derby, DE2-0JU.  
DUNDALK: D. M. Jones, G13KVD, 6 Mullagh Place, Limavady, Co. Derry, N. Ireland.  
DUNSTABLE DOWNS: C. G. Powell, G8BPK, 1 Wenwell Close, Buckland Wharf, Aston Clinton, Aylesbury (630600), Bucks.  
ECHELFORD: V. W. Higgs, G3VWJ, 205 Commercial Road, Staines, Middx.  
EDGWARE: A. Masson, G3PSP, 62 Coldharbour Lane, Bushey WD2-3NY (01-950 6827), Herts.  
FARNBOROUGH: A. M. Stretton, G8FWE, 10 Sirhurst Road, Camberley (22887), Surrey, GU15-3AW.  
HAVERING: S. J. Hobday, G3SKV, 31 Sackville Crescent, Harold Wood, Romford, RM3-OEJ, Essex.  
HORSHAM: T. Wadsworth, G3NPF, 39 Church Road, Broadbridge Heath, Horsham (66290), Sussex.  
KETTERING: I. L. Holmes, 8 Hall Lane, Kettering (3767), Northants.  
KINGSTON: R. S. Babbs, G3GVU, 28 Grove Lane, Kingston-on-Thames (01-546 2801), Surrey.  
LICHFIELD: R. Smethers, G3NLY, 46 Church Road, Burntwood, Walsall, WS7-9EA, Staffs.  
LINCOLN: F. Day, G4BXL, 5 St. Marks Avenue, Cherry Willingham, Lincoln (51058), LN3-4LX.  
LOTHIANS: B. Howie, GM8DJJ, 3 Libberton Brae, Edinburgh, EH16-6AQ.  
MAIDENHEAD: A. K. Chennell, 10 Lower Cippenham Lane, Slough (20417), SL1-5DF.  
MEDWAY: H. E. Willis, 111 Laburnum Road, Strood, Kent, ME2-2LB. (Medway 76953.)  
MIDLAND: N. Gutteridge, G8BHE, 68 Max Road, Quinton, Birmingham 32. (021-422 9787.)

NEWBURY: D. J. Williams, G8FNS, Damar, Cold Ash Hill, Cold Ash, Newbury, Berks.  
NIGERIAN: E. A. Lomax, 5N2ABC, P.O. Box 68, Kaduna, Nigeria.  
NORTH BUCKS: R. J. Pye, G8AAT, 7 Meadow View, Potters-pury, Towcester. (Yardley Gobion 640.)  
NORTH DEVON: H. G. Hughes, G4CG, Crinnis, High Wall, Sticklepath, Barnstaple, Devon.  
NOTTINGHAM: S. F. Clarringburn, 49 Fernleigh Avenue, Westdale Lane, Nottingham, NG3-6FN.  
PLYMOUTH: C. Mitchell, G3UVS, Kechil Rumah, Green Lane, Yelverton, Devon, PL20-6BW.  
R.A.I.B.C.: Mrs. F. Woolley, G3LWY, Woodclose, Pensewood, Wincanton, Somerset.  
READING: D. King, 34 Crawshay Drive, Emmer Green, Reading, RG4-8SY, Berks.  
REIGATE: F. H. Mundy, G3XSZ, 2 Conifer Close, Reigate (43130), Surrey.  
ROYAL NAVY: A. G. Walker, 4 Woodcroft Gardens, Love-dean, PO8-9PZ.  
SHEFFIELD: S. Illman, G6VF, 134 Baslow Road, Totley, Sheffield, S17-4DR.  
SLADE: J. E. Drakeley, G8GRC, 186 Conway Road, Chelmsley Wood, Birmingham, 37.  
SOUTH BIRMINGHAM: R. J. Thompson, G8GDZ, 23 Fox Hill, Selly Oak, Birmingham, 29. (021-472 0533.)  
SOUTH MANCHESTER: D. Holland, G3WFT, 7 Alcester Road, Sale, Cheshire, M33-3GW.  
STAR: T. Leeman, G4BUU, 115 Asket Drive, Seacroft, Leeds, LS14-1HX.  
STOWMARKET: A. P. Ashton, G3XAP, 30 Ford View Road, Stowmarket, IP14-2BL, Suffolk.  
SURREY: S. A. Morley, G3FWR, 22 Old Farleigh Road, Selsdon, CR2-8PB. (01-657 3258.)  
SUTTON & CHEAM: A. Kecch, G4BOX, 26 St. Albans Road, Cheam, Sutton, Surrey.  
THAMES VALLEY: C. B. Seaman, G3ATF, 40 Park Road, Ashford (56030), Middx.  
TORBAY: M. Yates, G3UIQ, Top Flat, 23 Waverley Road, Newton Abbot, Devon.  
VERULAM: H. Young, G3YHY, 93 Leaford Crescent, Watford, WD2-5JQ, Herts.  
WEST KENT: S. E. Jones, G4BKG, 36A London Road, Southborough, Kent.  
WHITE ROSE: R. Nettleton, G3YED, 129 Stainbeck Lane, Leeds, LS7-2EB.  
WIRRAL: A. Fisher, G3WSD, 34 Glenmore Road, Oxtou, Birkenhead, Cheshire.  
WOLVERHAMPTON: J. P. H. Burden, G3UBX, 28 Coalway Road, Wolverhampton, WV3-7LX.  
WORCESTER: B. A. Jones, G8ASO, 12 Woodside Road, Larkhill, Worcester (29208), WR5-2EG.  
WORTHING: G. Hooper, G8ETL, 12 Bramble Crescent, Durrington, Worthing (62013).  
YEOVIL: D. L. McLean, G3NOF, 9 Cedar Grove, Yeovil, Somerset.

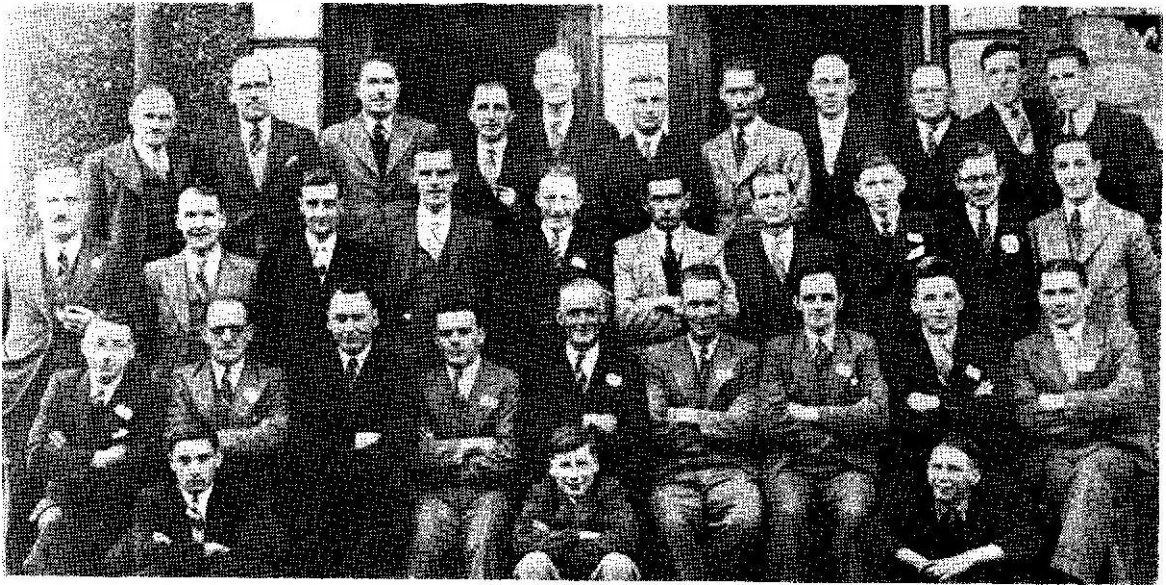

A fine Club photograph of many years ago—it was taken in 1938 on the occasion of the annual dinner of the Rhondda Radio Society. Unfortunately, at this distance of time, few call signs can be identified. Support was drawn from a large area of South Wales. It is noteworthy that for this more or less formal occasion everybody wore a collar-and-tie, with his hair cut and neatly brushed—also that the distaff side is conspicuous by its absence. Other times—other manners!

shack. Wednesdays are the main meetings, and the July programme runs something like this: July 4, a Surplus Auction; July 11, a talk on Mobile Operation by Tom Darn, G3FGY; July 18, a D/F event; and on July 25, a tape-and-slide lecture by VK4KS, on the DX-pedition to Mellish Reef.

There is a regular pattern to the weekly Wednesday meetings of the Star club in Leeds. The first one is a tape-and-slide talk, the second is a Constructional session, the third a Communications night with the Club rig on the air, and the last Wednesday is a Bingo evening, the prizes of course being radio items. On a different line, they want to hear from ten or fifteen stations on Two who would take part in a relayed contact between the Star lads and a station either in North Scotland or down on the South Coast.

Up in Scotland now, to Lothians, who write to advise that there will be no more meetings until September. Furthermore, they will reconvene in a new Hq., the old place at Hanover Street being due to be demolished. Details from GM8DIJ—see Panel, opposite.

Now to Leeds and the White Rose group. They have Hq. at 83 Town Street, Armley, and meet every Wednesday evening. A highlight in July will be on the 11th, when Neil Glover, G3AAV, is coming along to talk about Two-metre Sideband.

If you are a member of the Bolton formation you probably join in the regular weekly nets, on Tuesdays, on 145.73 MHz at 1900z. However, on the third Tuesday in each month, you can go one better and put in an appearance at the get-together at the White Lion, Moor Lane, which constitutes the formal meeting of the Club.

Sheffield seem to have their Hq. at the Sheaf House Hotel, Bramall Lane; but for details of the current

goings-on we have to refer you to G6VF, address as in the Panel.

### Going West

Very westerly for a start, right to Dundalk, where a Club exists which is sponsoring a series of awards, rather like our WAB but based on the Irish Grid, details of which are given in our "Communications and DX News" feature. GI3KVD, up in Limavady, Co. Derry, is one of the people concerned, and in the absence of any other detail on the Club, we have, for the moment, put him in the appropriate column of the Secretaries' Panel, opposite.

Cornish serves a wide-flung area, having not only a main meeting at the SWEB Clubroom, Pool, Camborne, but also subsidiary groups at Newquay and Penzance. On July 5, after some discussion on the forthcoming Mobile Rally and a Question-and-Answer session, they will hear a talk by Gordon Nicholas, G3XTE, about Fluid Logic.

At Torbay it sounds as though Tuesday evenings are mainly devoted to the problems of R.A.E. and Morse, but there are also Saturday sessions, and the one on July 28 will cover the vital question of "What went wrong on NFD." The Hq. is at Bath Lane, rear of 94 Belgrave Road, Torquay.

Reading give no details of what goes on at their meetings on July 3, 17, and 31, but they do say all are welcome. The place to head for is the White Horse public house, Kidmore End Road, Emmer Green.

Nice to hear again from North Devon, who have their Hq. at Crinnis, High Wall, Sticklepath, Barnstaple. The dates are July 11, for a talk about sea-going radio operators and their work, and July 25 for a Ragchew.

Perhaps the most important item is the proposal to hold an R.A.E. class at North Devon College during the 1973/74 season—anyone interested please get in touch with the Secretary, G4CG, *immediately*.

The AGM has just been taken at **Yeovil**, where G3NOF returns for yet another year as hon. secretary—the lads obviously know they have a good one and don't mean to let him off the hook! Meet them by going to the Youth Centre, 31 The Park, Yeovil, on any Thursday.

A long letter from the new Secretary at **Plymouth** tells us more about the group than we could ever use in this space, but at the same time gives your conductor a good picture of the activity. At the Hq., Virginia House, Brestonside, they are planning to have two shacks, one for SWL's and one for the transmitting types. Lectures and film shows are being lined up for the autumn season, and plans made for a Picnic on August 5 on Yelverton Down where refreshments will be laid on, and there is hoped to be a display of radio-controlled model flying; talk-in of course, on Top Band and Two.

#### South-East

A big clip this, as one would expect. At the top we find **Verulam** who will be hearing G3AAZ on July 18, talking about Systems Engineering, the venue being the Market Hall, St. Albans, at 7.30 for an 8.0 p.m. start.

South of the Thames now, to the **Thames Valley Club** which is now fifty years old, and has had many names in the industry among its members. They have recently changed their Hq. address, and now get together on the first Wednesday of each month, at the King George Hall in Esher, next to the fire station. (Incidentally, the hon. secretary's callsign was given wrongly in the photo-caption on p.241 of our last—it should be G3ATF).

**Havering and District** use the British Legion Hq., Western Road, Romford, as their home, getting together on alternate Wednesdays, which gives July 11 and 25. The first of these is a Top Band D/F evening, while the latter date is probably a visit to North Weald radio station, but may be a business meeting if necessary—no doubt G3SKV would give the latest details—see Panel.

**Chiltern** seems to be an active crew, based on the Ernest Turner factory in Totteridge Avenue, High Wycombe. We seem to be talking a little ahead of the organised programme, but we can tell you the dates are July 10, for the informal, and July 25 for the "main" event of the month.

As usual there are two dates in July for **Cray Valley**; July 5 sees G30OU and G3FZL combining forces to give a talk on Semiconductors and Stabilised Power supplies, and the 19th is purely an informal, both being at the United Reformed Church Hall, Court Road, Eltham, London, S.E.9.

If you are in **Reigate** on July 17, head for the St. Mark's Church Hall in Alma Road, and you will hear G3JMJ talking about Top Band topics, mainly for the benefit of the newcomer. July 3 is an informal, in the Marquis of Granby, Hooley Lane, Redhill.

The usual weekly arrangements apply at **Dunstable Downs**; the gatherings are at Chews House, 77 High Street South, Dunstable, as follows: July 6 is set aside for the final arrangements for their participation in the VHF/UHF contest, while July 13 is what they like to call a "between week." July 20 is given over to a demonstration of amateur TV, and July 27 to the erection of the marquee on the Down, and final preparations for the exhibition station that is to be mounted inside it, over the following weekend July 28-29.

The **Medway** chaps have a regular Friday booking at the Aurora Hotel in Gillingham, where the formal meeting starts at 2000, in order that R.A.E. students may have the previous hour for their classes.

A change in the slate of officers of some magnitude occurred at the recent AGM of the **Sutton and Cheam** crowd, due mainly to the departure of G3HQX to the Winchester area to live. However, it does not for the moment affect the venue, still to remain at the "Harrow" in Cheam, on July 17, when G3HSP gives his follow-up talk on Marine radio operation.

A long time since last we heard from **Newbury**, who are still using the South Berks College of Further Education as their Hq. July 2 is the next date booked, for a talk on a VHF subject from 7.30 to 9.30 p.m.

#### SHORT CLUB NOTICES

CLUB NAME	HEADQUARTERS LOCATION	MEETING MONTHLY
Acton, Brentford & Chiswick	66 High Road, Chiswick	July 17
Basingstoke	Chineham House, Popley Basingstoke	July 7, 21
Bedford	"The Dolphin," The Broadway	July 5, 12, 19, 26
Crystal Palace	Emmanuel Church Hall, Barry Road, S.E. 22	July 21
Derby (Nunsfield)	Nunsfield House, Boulton Lane, Alvaston	July 6, 13, 20, 27
Edgware	145 Orange Hill Road, Edgware	July 12, 26
Farnborough	<i>Not quoted</i>	July 10
Horsham	Guide Hall, Denne Road	July 3, 17
S. Birmingham	Hampstead House, Fairfax Road, West Heath	July 4
Lincoln	Astronomical Society Hq., Westcliffe Street	July 4, 11, 18, 25
Nottingham	Community Centre, Mansheld Road, Nottingham	July 5, 12, 19, 26
Stowmarket	Adult Centre, Onehouse Road, Stowmarket	July 2
Worcester	Old Pheasant, New Street	July 2, 21
Worthing	Rose Wilmot Centre, Littlchampton Road	July 3, 10, 17, 24, 31

NB —In each case, the Secretary's name and address appears in the Panel, on p 304

---

When the Cornish Amateur Radio Club put on a station for the Open Day at the Technical College, Carnborne, G2ABC did some air-testing, watched by G8DZE, G4DHD and G8FSX.

---

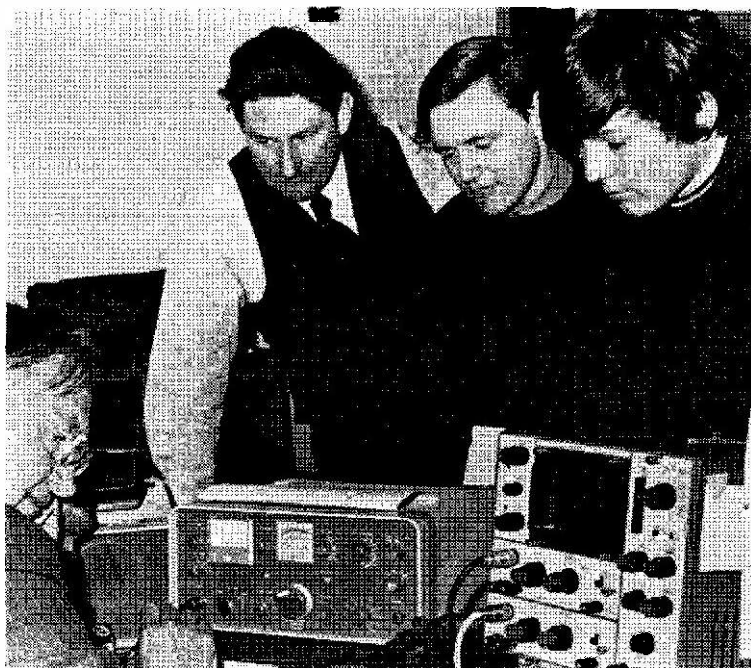

Nothing like a change, says the **Kingston** chaps; they have had a talk or something laid on at every meeting for the past couple of years, so there should be plenty of nattering done at the July 11 session for which nothing has been arranged. They now meet at the Scout Hq., Stirling Walk, Raeburn Avenue, Surbiton, at the rear of the Lagoon. Incidentally one of the useful Club activities is the Morse class, held every week on Wednesday evenings.

For **Bishops Stortford** the date is always the third Monday in the month, at the Royal British Legion Club at the top of Windhill. July 16's programme is, at the time of writing, not finalised completely, but something will be happening for certain, says the Secretary.

July in **Echelford** gives two dates. The first one, July 9, is still not settled at the time of writing, but on July 26, G3HSP will be talking about Marine operation. The meetings are both at St. Martins Court, Kingston Crescent, Ashford, Middlesex.

Pessimists they are at **West Kent** where they are not committing themselves as to what will happen on July 13. As for July 27, the evening will be in two parts, the first being planning for VHF NFD, the second in the form of an "Any Questions" session about VHF topics.

July 17 is the date the **Surrey** lads have booked, at

the "Swan and Sugarloaf" in South Croydon, when G3YJC will be talking about the design and construction of Digital Frequency Counters, to lead, possibly to a Club Project in the foreseeable future.

Their new secretary writes in from **Maidenhead**, to let us know how they are getting along. The chaps still have their Hq. at the Victory Hall, Cox Green, Maidenhead, and on July 2 will be listening to G4CDZ talking and demonstrating RTTY on VHF. As for July 17, this is the Grand Junk Sale—an opportunity to change the scenery in the shack!

#### Sign-Off

We seem to have dealt with all the current crop of reports. Your next ones, covering your club programme for *August* should be posted to arrive with us by **July 5**, addressed "Club Secretary," SHORT WAVE MAGAZINE, BUCKINGHAM, MK18 1RQ.

*Editorial Note:* Reports too late for taking into this piece were received from the following Clubs: Mid-Sussex, BARTG, Southgate, York and Stevenage. As frequently explained, our production schedule is so tight that we cannot write-in reports received after the deadline.

---

*"Short Wave Magazine" covers the whole field of Amateur Radio  
and should be obtainable to order through any newsagent.*

---

# NEW QTH's

This space is available for the publication of the addresses of all holders of new U.K. call signs, as issued or changes of address of transmitters already licensed. All addresses published here will be reprinted in the U.K. section of the "RADIO AMATEUR CALL BOOK" in preparation. QTH's are inserted as they are received, up to the limit of the space allowance each month. Please write clearly and address on a separate slip to QTH Section.

- GM3WKM**, K. G. Melton, 23 Tuzo Close, Balivanich, Isle of Benbecula, Outer Hebrides.
- G4BLW**, E. Evans, The Ramblers, 55 Church Lane, Holton-Le-Clay, Grimsby, Lincs. (Tel. *Grimsby 822596*.)
- G4BVY**, I. R. Dixon, 8 Kingsway, Skipton, Yorkshire, BD23 1BA.
- G4BWP**, F. C. Handscombe (*ex-G8HAW*), 24 Hitchin Road, Henlow, Beds. SB16 6BB.
- G4BXU**, G. W. Butler, Lulworth Private Hotel, 8 Surrey Road, Cliftonville, Kent. (Tel. *Thanet 20009*.)
- G4BYV**, J. Tye (*ex-G8BYV*), Internos, Swanton Morley, Dereham, Norfolk.
- G4CBK**, L. H. Weston, 52 Shireview Road, Pelsall, Walsall, Staffs.
- G4CCF**, Royal Signals Amateur Radio Society (Cadet Forces Section), School of Signals, Blandford Camp, Blandford Forum, Dorset.
- G4CCQ**, M. Stanton (*ex-G8GNH*), Sweetbourne Cottage, Hastings Road, Lamberhurst, Tunbridge Wells, Kent, TN3 8JG.
- G4CDP**, J. Everett (*ex-G8FAJ*), Marloes, Comp Lane, St. Marys Platt, Sevenoaks, Kent.
- G4CDQ**, N. H. Gordon, 59 Lower Howsell Road, Malvern, Worcs., WR14 1DP.
- G4CDT**, A. R. Dexter, 41 Bedford Road, Shefford, Beds., SG17 5DJ. (Tel. *Chicksands 7497*.)
- G4CEC**, P. V. Knight, 7 St. Marks Close, Rushden, Northants. NN10 9QS.
- G4CED**, G. E. Coward, 41 Bakers Lane, Southport, Lincs., PRN 9RM. (Tel. *Southport 87279*.)
- G4CEP**, G. R. Morris, 90 The Promenade, Withernsea, East Yorkshire, HU19 2JE.
- GW5CBN**, W. P. Binger, The Flat, Bryn Ioreyn Manor, Caergwrle, Wrexham, Denbighshire.
- G8AIP**, M. C. Osment, 194 Fernhill, Harlow, Essex, CM18 7LG.
- G8BDA**, P. J. Harvey, 8 Walnut Drive, Witham, Essex.
- G18GTM**, H. McLroy, 28 Curran's Brae, Moy, Co. Tyrone.
- G8GWT**, R. H. Young, 22-A Lambourn Road, Clapham Northside, London, S.W.4.
- G8GYA**, J. T. Hilton, 4 High Street, Dover, Kent, CT16 1DR. (Tel. *0304 206 460*.)
- G8GYG**, P. Allan, 2 Park View, Queensbury, Bradford, Yorkshire, BD13 1PL. (Tel. *Bradford 882354*.)
- G8GYM**, R. D. Claridge, 124 Pemdevon Road, West Croydon, Surrey, CR0 3QP.
- G8HDS**, P. W. MacKimm, 47 Chatburn Square, Castleton, Rochdale, Lancs., OL11 2YF.
- G8HEP**, B. R. Hughes, 46 Leinster Gardens, London, W2 3AT.
- G8HFW**, T. E. Hall, 23 Burcott Gardens, Addlestone, Weybridge, Surrey, KT15 2DE.
- G8HHD**, H. Foster, 9 Meadows Avenue, Thornton Cleveleys, Lancs. (Tel. *Cleveleys 5939*.)
- G8HIM**, A. G. Falla, Flat 3, Lamcote House, Radcliffe-on-Trent, Notts.
- G8HJO**, A. D. Lincoln, 62 Chapel Street, Halton, Leeds, Yorkshire, LS15 7RG. (Tel. *Leeds 647120*.)
- G8HKE**, M. A. Holder, Carlton, 23 Woodhill Avenue, Portishead, Bristol, Somerset, BS20 9EX.
- G8HKI**, E. F. Trickey, 53 Hollyguest Road, Hanham, Bristol, BS15 3RN. (Tel. *0272 671409*.)
- G8HKO**, M. J. Beecham, 22 Liquorpond Street, Boston, Lincs., PE21 8UF. (Tel. *Boston 3747*.)
- CHANGE OF ADDRESS**
- G2AXO**, W. J. Purser, 2 Dobson Close, Great Houghton, Northampton. (Tel. *Northampton 61794*.)
- G3AKG**, P. J. Fay, 5 Harland Way, The Glebe, Washington, Co. Durham.
- GM3ITN**, L. Hamilton, Hallsland, Hardgate, Clydebank.
- G3JFF**, M. J. Matthews, *H.M.S. Hermes*, B.F.P.O. Ships, London.
- G3NPY**, J. Joslin, 195 Roman Bank, Skegness, Lincs.
- G3PHN**, S. B. Lord, 14 Dorset Drive, Moira, Burton-on-Trent, Staffs.
- G3PXV**, R. E. Wiseman, 3 Squires Close, Somersham, Huntingdonshire, PE17 3HT. (Tel. *Somersham 489*.)
- G3RGF**, R. D. V. Young, Ranelagh, 138 Main Road, Danbury, Chelmsford, Essex, CM3 4DT.
- G3RQR**, N. L. Kirtley, 14 Byron Avenue, Winchester, Hants. (Tel. *Winchester 68565*.)
- GM3SZP**, R. Paton, 61 Waterside Road, Kirkintilloch, Glasgow, G66 3QW. (Tel. *041-776 6650*.)
- G3TSH**, R. J. Wilcox (*ex-GW3TSH*), 8 Jane Street, Chadderton, Oldham, Lancs. OL9 8QP. (Tel. *061-624 7667*.)
- GW3TSH/A**, R. J. Wilcox, 33 Treowen Road, Pembroke Dock, Pembrokeshire. (Tel. *Pembroke 2771*.)
- G3UUZ**, H. Bluer (*ex-GW3UUZ*), Anvil Point Lighthouse, Swanage, Dorset.
- G3VFX**, D. N. Davison, 75 Shaftesbury Avenue, South Harrow, Middlesex. (Tel. *01-864 3629*.)
- G3WXB**, K. Watmough, Woodlands, Warren Close, Meads, Eastbourne, Sussex.
- G3XDD**, S. C. Crampton, 11 Pine-wood Avenue, Brookhouse, Lancaster, Lancs., LA2 9NU. (Tel. *Caton 770738*.)
- G3XVP**, P. V. Pimblott, 52 Park Edge Close, Leeds 8, Yorkshire.
- G4AHO**, K. M. Jones (*ex-ZC4KJ /5B4AK*), 31 Brookfield Road, Haversham, Wolverton, Bucks.
- G4BOW**, R. A. Royall, The Rectory, 63 Coborn Road, Mile End, London, E3 2DB. (Tel. *01-980 2074*.)
- G4IV**, E. T. Carter, Bass Point Bungalow, The Lizard, Helston, Cornwall, TR12 7AP.
- G4RJ**, B. Farleigh, 22 Hillhead Park, Brixham, Devon.
- G8BPA**, M. E. Kirk, Pet Store, 8 Broad Street, Spalding, Lincs.
- G8CZM**, K. A. Jones, 57 Frankley Avenue, Halesowen, Worcs.

**TRANSISTOR DATA**  
The INTERNATIONAL TRANSISTOR  
DATA MANUAL

1973 Edition is now ready. Data on upwards of 18,000 transistors of international origin and other valuable information. £5.60 in U.K., £7.10 overseas includes post and packing.

Brochure available. Cash with Order. Direct from

**SEMICON INDEXES LTD.,**  
Freeport, Wokingham, Berks., RG11 1BR

**MOSFET CONVERTERS**  
for 2 metres

- \* 28-30 MHz I.F.
- \* Isolated, stabilised supply—operates from 9 to 15v.
- \* Anodised housing— $4\frac{1}{2} \times 2\frac{1}{2} \times 1\frac{1}{2}$  inches.
- \* Price? £9.95 inc. postage. S.A.E. enquiries please.

**G3OLB ; 5 Derwent Court, Thornbury, Bristol**  
Tel. Oldbury 4559

**SMALL ADVERTISEMENTS**

("SITUATIONS" AND "TRADE")

6p per word, minimum charge £1.00. No series discount. All charges payable with order. Insertions of radio interest only accepted. Add 50% for Bold Face (Heavy Type). Box Numbers 15p extra. No responsibility accepted for transcription errors. Replies to Box Numbers should be addressed to The Short Wave Magazine, 55 Victoria Street, London, SW1H 0HF.

**TRADE**

**AT LAST**, an Independent QSL Bureau. Let us handle your out-going QSL's. For details send s.a.e. to: **A.B. QSL Bureau, Box No. 5154, Short Wave Magazine Ltd., 55 Victoria Street, London, SW1H-0HF.**

**JR-310** super de luxe, 160m., calibration unit, 29.5 to 30.1 MHz coverage, better on 40m., send for test report, price £93.50 including VAT. Also JR-310 accessories, VAT and post paid: 10AZ CW or SSB filters, £16.50. Crystals, specially made wire-in (sorry, no mod. details) for Top Band, £3.00, and 29.5 to 30.1 MHz, £3.30.—**Leeming, G3LLL, Holdings, 39/41 Mincing Lane, Blackburn, Lancs., BB2 2AF.** (Tel: 59595/6).

**QSL Cards** for Tx and SWL. Send s.a.c. for samples stating which type required.—**Beaumont, G5YV, 8 Ashfield Avenue, Morley, Leeds, LS27-0QD.**

**QSL CARDS** and G.P.O. approved Logs (hard back), prompt delivery. Send 4p stamp for samples.—**Atkinson Bros., Printers, Looe, Cornwall, PL13-1JT.**

**LARGE Quantity Test Equipment**, receivers, transceivers, meters, Variacs, and PSU's. Over 1,000 items of this sort for immediate disposal. Send s.a.e. for list; 25p refunded on purchases over £2.00.—**F.J.C., Colne Mill, Alvington, Lydney, Glos., GL15 6AB.**

**VERNITRON Ceramic Filter Resonators**, 455 kHz. Special types for SSB and NBFM. Send s.a.e. for list.—**Amatronic, Ltd., 396 Selsdon Road, South Croydon, Surrey. CR2 0DE.**

**RECEIVER Module RM-A**: Small circuit board, carrying 45 components, including R.C.A. IC. IFT's, FET osc. and BFO. For 9-volt operation, with headphone output. Requires only tuned circuits and controls (not included) to make up a AM/CW/SSB superhet Rx tuning to 30 MHz. Prototype has logged WIBB on Top Band, ZL4BO on Eighty and SSB/DX down to 10 metres. Good converter IF. Price £7.85. Send s.a.e. for details.—**Golledge, G3EDW, Glentor, Torrington, North Devon.**

**AUGUST Issue: Due out July 27. Single-copy orders** 30p, post free, to reach us by Wednesday, July 25, for posting on July 26.—**Circulation Dept., Short Wave Magazine Ltd., 55 Victoria Street, London, SW1H-0HF.**

**READERS ADVERTISEMENTS**

3p per word, minimum charge 50p payable with order. Add 25% for Bold Face (Heavy Type). Please write clearly, using full punctuation and recognised abbreviations. No responsibility accepted for transcription errors. Box Numbers 15p extra. Replies to Box Numbers should be addressed to The Short Wave Magazine, 55 Victoria Street, London, SW1H 0HF.

**READERS**

**SALE**: SB-102 transceiver, brand new, professionally wired, with AC power supply, £230 or near offer. Ring Menzies, 041-639 2173 between 6 and 7 p.m. (Glasgow).—**Box No. 5151, Short Wave Magazine Ltd., 55 Victoria Street, London SW1H-0HF.**

**SELLING**: Three Sinclair 250's, two brand new at £4.50 each, and one almost new at £4; P.28 PSU, almost new, £6.80; Sanken SI-1025A 25-watt audio amp. IC, with data, as new, £6. (Manchester).—**Box No. 5152, Short Wave Magazine Ltd., 55 Victoria Street, London. SW1H-0HF.**

**FOR SALE**: Transistor HF converter, £4; RSGB "Radio Communications Handbook," £2.50; 1971/2 "Call Books," £1; 1973 "DX Call Book," £2. (Leeds).—**Box No. 5153, Short Wave Magazine Ltd., 55 Victoria Street, London SW1H-0HF.**

**OFFERING**: National HRO-500 receiver and LF pre-selector, 5 kHz to 30 MHz, sensible offers please. All letters answered.—**Wilberforce, G4AXS, Little Yaffes, Womenswold, Canterbury, Kent.** (Tel: Barham 362).

**WANTED**: Cathodeon 1.4 MHz filter type USB1 (will exchange LSB1 for this if required); also carrier crystal for above, and High Band AM Band. —**Holburn, G3XZP, QTHR.**

**SELLING**: K.W. Atlanta, brand new, excellent buy, £150; FT-75 with two power supplies and external VFO, £120; K.W. SWR bridge, £5.—**Ring Goodbody, G3YQE, 01-592 7800.**

**SELLING**: Hy-Gain 18-AVT 10-80m. vertical aerial £18; Heathkit SB-610E monitor 'scope, mint, £45; Heathkit RA-1 receiver, xtal calibrator, £20. Buyers collect for cash.—**Metcalfe, Thorndale, Caerwys, Mold, Flintshire.**

**FOR SALE**: Trio JR-310 communications receiver with matching SP-5DS speaker, both in excellent condition, £65; Unica UR-1A receiver, £18.—**Darby, 52 Lenville Way, Rotherhithe, London, SE16 3HJ.** (Tel: 01-237 9784).

**SALE**: **R.216** receiver, coverage 19-156 MHz, with AC/PSU and circuit diagram, £75; Windsor 65C signal generator, 100 kHz to 160 MHz, 6 bands, circuit diagram, needs alignment, £6; Signal generator Type 106, 5.5-55 MHz, £4; Hallicrafters S.27 Rx. coverage 27-144 MHz, needs alignment, £12; Taylor 45C valve tester, £7.50; **WANTED**: Sentinel X dual gate Mosfet 2-metre converter, will part-exchange any of above.—**Hughes, Rock House, Flint Mountain, Flint CH6 5QG.** (Tel: Northop 279).

**SILENT-KEY SALE:** Trio TS-510 and PSU with Shure mic., and K.W. LPF, little used, no mods., CW filter not fitted, best offer over £185. Inspection SW London.—BM/Ethos, London, W1.

**FOR SALE:** Eddystone EC-10 Mk. II, new, 365.—Ring Walmsley, Nottingham 269109.

**SELLING:** K.W. 2000A complete with AC/PSU, Shure 201 mic. and manual, £150; Heathkit SB-200 linear amplifier with manual (new mid-'72), £110. All in excellent condition.—Axford, G4AQZ, QTHR (Tel: Thorpe-le-Soken 632).

**OFFERING:** "G2DAF"-type Mk. II Rx and "G2DAF"-type Mk. II Tx with 4X250B in output stage and separate power unit. Both in good condition, will sell separately if necessary, inspection invited. Examine before offer. Pye Vanguard AM-25B, complete with xtals on 145.8 MHz, £18; Heathkit OS-1, £4. Buyers collect. **WANTED:** First class SB-200 and SB-640. Details and price, please.—Airey, G3GEJ, 19 Horseman Drive, Copmanthorpe, York (66453).

**SALE:** Beltex 5400 2-metre transceiver, new, boxed, a complete station, £60 (shop price £75 plus VAT). will deliver reasonable distance.—Osborn, 32 Bushey Mill Crescent, Watford (29984), Herts.

**OFFERING:** Vespa Mk. II, with AC/PSU and extra 21 MHz crystal, spare PA valves, Shure mic. and other items, as new. Buyer arranges transport.—Mildren, G3FVD, QTHR. (Tel: Bodmin 2487).

**WANTED:** Codar Q-multiplier, must be in good condition. Details and price please.—Dowling, Ballytiglea, Borris, Co. Carlow, Ireland.

**SALE:** AR-22R rotator with 70-ft. cable, £20; KW-202 speaker unit, £3. Prefer buyers collect.—Baker, 65 Crompton Street, Chelmsford, Essex.

**SALE:** K.W. Valiant with PSU; Lafayette HA-600; also home-built Top-Band Tx. £60 The Lot.—Berwick, G4BOP. (Tel: 0702-24 4105 after 6 p.m.).

**JUST GOT YOUR G4/3?** Complete rig offered: Eddystone 840C, home-built Vanguard Tx with 160m. mod., variometer ATU, bargain £58 or best offer. Delivered 30 miles radius of Birmingham.—Parish, 5 Pinewood Close, Rubery, Birmingham B45 9HE.

**FOR SALE:** Trio TS-500 transceiver with PS-500 and remote VFO-5 dynamic microphone, excellent condition. £90. Have gone QRT.—Llewelyn, GW3RXD, 33 Awelfryn, Amlwch, Anglesey.

**EXCHANGE:** Trio 9R-59DS receiver with SP-5DS speaker and service manual FOR complete 2-metre FM mobile, preferably fully tunable Rx. No rubbish please. Cash adjustment if necessary.—Ring Russell, 01-977 7705 evenings.

**WANTED:** K.W. Vespa Tx with PSU, E-Zec Match. 103 or 101 meter, Shure 444 mic. All must be in good condition.—Johnstone, Waverley, Golspie (325), KW10 6SR, Sutherland, Scotland.

**WANTED:** For FT-101: Car mounting bracket, aerial tuning unit and cooling fan. Details and price please.—400 Edgware Road, London. (Tel: 01-723 5521).

**SELLING:** Collins R-390A/URR manual, £2; BC-221AK, £12.50; Half R.216 receiver, £10; AN/URT-33 transmitter, £4.50. (Manchester).—Box No. 5155, Short Wave Magazine Ltd., 55 Victoria Street, London, SW1H-0HF.

**WANTED:** For Heathkit HW-32A SSB transceiver: HP-13 mobile PSU and HP-23 fixed station PSU. Details and price please, call or write. Club meetings every Wednesday at 8 p.m.—Star Radio Club, New Inn Hotel, Bramley Town Street, Bramley, Leeds 13.

**SALE:** Pair of 6146's, seldom used, £2; RSGB "Radio Communication Handbooks," 1970 to 1972, £1.30; 100 kHz xtal transistor marker, £1.50; "ARRL Handbook," 1936, £1. New and boxed: one 6J6 and four 6AK5, £1.15.—Duncan, 12 Ivanhoe Place, Lunde.

**WANTED:** Modified 19 Set Rx/Tx for Top Band operation. Details please.—King, 2 Bushell House, Bentons Lane, Westnorwood, London, SE27 9TS.

**FOR SALE:** KW-202 with calibrator and phones, new last March, first £100 secures.—Williams, 39 Clockhouse Way, Braintree, Essex CM7 6RD.

**WANTED:** Spares for R-390A/URR and R-417/TRC receivers; sub-units etc. in any condition. **FOR SALE:** IF unit for R-390/URR receiver. Offers?—Laskaris, 4 Alpine Close, Woodlands Road, Bromley, Kent. (Tel: 01-467 0162 after 7 p.m.).

**SALE:** KW-2000 G-line, excellent condition, £100; KW-1000 linear, as new, £90. Both with manuals. Delivery reasonable distance.—Kirk, Merris Court, Churchill, Oxford. (Tel: Kingham 270).

**SELLING:** IIV-100 with HP-23 PSU, both in mint condition, £120. Prefer buyer collects.—Linney, G3VQL, QTHR. (Tel: Shrewsbury 51733).

**SELLING:** 2m. AM Cambridge, dash-mounted with cradle, Tx/Rx aligned on 2m., with crystals, very clean, £40; DJ9ZR 2m. SSB TTx, complete with K.V.G. 9 MHz filter and VXO giving 100 kHz swing per channel. £30; 70 cm. Varactor tripler, up to 15 watts output, microstrip lines, £15; Heathkit GD-1U with extra IFT range coils, £12; Airmec 830 'scope, ideal for photographic work (heavy — callers only), £10; BC-454 Rx, 3.0-6.0 MHz, with output transformer inside, ideal tunable IF, immaculate condition, £8; Various used VHF aerials.—Sneap, G3ZYC, QTHR. (Tel: Ripley [0733] 3883, Derbys.).

**DESPERATELY WANTED:** Transformer with 240v. primary, and 60-120v. with at least 12A. secondary; also any MW D/F equipment, receivers, aerials and any such information!—Richardson, 30 Gainsborough Road, North Finchley, London, N12 8AG.

**OFFERS OR EXCHANGE:** Ex-Govt. "Moaning Minnie" intercom., takes 12 extensions; Valve variable stabiliser; 45 copies "Practical Wireless," 1944-51.—Ring Aufenast, 01-656 1766.

**SALE:** Heath HW-100 with HP-13 DC/PSU and handbook, £110; Yaesu FT-75 transceiver with FP-75 AC/PSU and DC-75 DC/PSU, extra xtals for 37.40, 37.50, 140.75 and 141.70 MHz, 2 handbooks (U.K. and J.A.), good condition and only 5 months old. £120. Delivery 100 miles.—Partridge, 2 York Crescent, Torquay. (Tel: 0803 34904).



**FOR SALE:** Viceroy Mk. III, £65; two CR-150's, £20; Heathkit DX-100U, £25; Panda PR-120V Tx, £20; HRO's, £20-£30.—de la Bertauche, G3RCO, QTHR. (Tel: Seaton 21016).

**SELLING:** T.W. 2m. transceiver with ten crystals and preamp, etc. Also new Heath GDO; unused Skybeam aerial; Books like "Basic Electronics." Please write for list.—Burnett, G8GVF, 4 Dale Road, Norton, Stourbridge, Worcs.

**SALE:** HW-100 transceiver with mains home-built PSU, in excellent condition, £95. Buyer collects.—Crabbe, G3WFM, 47 Torrington Drive, Potters Bar (51532), Herts.

**SELLING:** FT-200 with AC/PSU, immaculate condition, £130. No offers. Can deliver up to 40 miles, or buyer collects (S. Bucks).—Fowler, G3IQF, QTHR. (Tel: Marlow 6421).

**FOR SALE:** Sommerkamp FR-100B amateur band receiver, coverage 160-10m., excellent condition. £75. WANTED: Eddystone 888A receiver.—Davies, 24 Upland Grove, Leeds 8. (Tel: 0532-656888).

**WANTED:** Hammarlund SP-600 and R.C.A. AR8516L receivers. Details of condition and price, please. **SALE:** IIRO dial, new, boxed, £3-50. Original manuals: 51-J3, £3-50; 51S1, 75S3, £4; RA-17L, £4-50. All plus postage.—Murray, 64 Moss Lane, Garstang, Lancs.

**SALE:** FT-DX400 (basic FT-DX401), mint, new May 1972, with pair of spare new boxed final valves and drivers, dynamic mic., £160. Delivery by arrangement, prefer buyer inspect.—Burgis, G6FB, 11 Morningside Avenue, Portchester, Fareham, Hants. (Tel: Portsmouth 21892, daytime).

**SELLING:** Eddystone 750 double-conversion general coverage receiver, with circuit and instructions, good condition, £32.—Ring Knox, Bradford (0274) 630266.

**FOR SALE:** Eddystone EC-10 Mk. II receiver, £45; Codar PR-30 self-powered preselector, £5. Also Codar AT-5 Tx, T.28 Rx, 12-MS mobile PSU, 12R/C control switching, complete with Halson mobile aerial, £30.—Druce, 6 Kennedy Drive, Goole, Yorks.

**SELLING:** KW-204 Tx, 7 months old, £130.—Long, Room 16 North, YWCA, Fourth Avenue, Harlow (31146/7), Essex CM20 1DN.

**SELLING:** Factory-built Heathkit GR-78, excellent condition, built-in speaker, complete with matching headphones and manual, £65.—Arrowsmith, 16 Mancetter Road, Mancetter, Atherstone, Warwickshire.

**SALE:** AR88LF receiver with matching speaker. K.W. Gelson converter and circuit diagram, both in good working condition, bargain £30, no offers; Eddystone 680X in good condition, bargain, £40, no offers.—Ring Gallet, 01-788 8208.

**OFFERING:** Collins 515-1 and 55G-1, mint condition, as new, kept as standby gear and very little used, with manual, etc. Collins equipment: PM-2 portable power supply for KWM-2; MP-1 mobile supply for KWM-2; 351D-2 mobile mount; 440E-1 power cable (new) for KWM-2. WANTED: Optional filters for 75S3-B and 312B-5. (Worcs).—Box No. 5156, Short Wave Magazine Ltd., 55 Victoria Street, London, SW1H-0HF.

**FOR SALE:** Eddystone 730/4 receiver, all new valves, good condition, £65; EC-10 Mk. II with aerial and mains PSU, mint, £65.—Fletcher, 62 Moorbridge Lane, Stapleford, Nottingham. (Tel: Sandiacre 3446).

**FOR SALE:** AR88 with fitted S-meter, excellent condition, £38; Eddystone EC-10, £28; BC-221 with calibration chart, £12-50; Philips tape recorder with mains unit, £8-50; NEV CC/TV complete 1-in. Dallmeyer, £35; Perdio portable TV with two Cossor 19-in. TV's, £10; Ferrograph 4AN, £35; KB 21-in. TV, £8; KB 23-in. TV, £22. For collection only.—Webb, 28 Pearce Avenue, Parkstone, Poole, Dorset. (Tel: 0202 741597).

**FOR SALE:** Eddystone EC-10 Mk. II receiver, little used, £60 or near offer.—Smith, G3JKS, QTHR. (Tel: Doncaster 841786).

**SELLING:** IIRO-5T with 6 coils, PSU, speaker, xtal calibrator and handbook, excellent condition. £20.—Quantrill, G3OPF, 10 Milford Avenue, Stony Stratford, Bucks.

**SPACE NEEDED:** Power units: 230v.-110v., £1; 230v.-130v., £1; 230v.-80v. with 80/130v. T/P motor supply, as new, £2-50. Marconi IU-13 terminal unit for narrow shifts, £20; Racal keying monitor Type 70480, £4; Imhoff case, suit RA-17 Rx, £10; Marconi signal generator Type CT-218, 85 kHz to 30 MHz, £25; Frequency meter, 15 Hz to 25 kHz, £10; Solartron audio oscillator Type OS-101, 25 Hz to 250 kHz, £15; JXK 4m. FET converter, £5; Creed 7B 24v. motor, useful spares, £1-50; Marconi VF bridge, £1; Burndep electronic relay, £5; Furzehill Standard Frequency, 1-10/100 kHz and 1 MHz, £10.—Ring Phillips, Haywards Heath 50265.

**SALE:** Hallicrafters SX-130 general coverage receiver, with bandspread, crystal filter and variable selectivity, £45; KW-1000 linear, £90. WANTED: SB-226 linear and Iiam-M rotator.—Ring Rabjohns, G3YBG, Exeter 74607.

**WANTED:** By professional: Eddystone EA-12. Details and realistic price, please.—Kille, 11 Higher Brimley Terrace, Teignmouth, Devon.

**SALE:** Yaesu FL-2100 linear, £130; Heathkit SB-620 spectrum analyser (built), £60; Osker SWR-200 SWR-PWR meter, £13; K.W. E-Zee Match, £10; Pair of R.C.A. 6146B's, unused, £3; Medco 50-ohm LP filter, £3; Eagle GDO, all coils, £5; Eddystone EC-10 Mk. I, £35; Sinclair Project-605 kit, new, £15; Pair of teak poly-planar speakers, £10; Pair of Lasky Sonics bookshelf speakers, £12.—Howes, G3AYA, 10 Millers Lane, Stanstead Abbots, Ware, Herts. (Tel: Ware 870010 home, or 01-634 4459 office).

**AUGUST Issue Short Wave Magazine due out on Friday, July 27. Single copies at 30p post free can be supplied to orders reaching us by Wednesday 25th, for despatch on Thursday 26th, the day before publication. These copies go out flat in an envelope, first-class posting. Limited supply only. Orders with remittance to:—Circulation Dept., Short Wave Magazine, Ltd., 55 Victoria Street, London, SW1H-0HF.**

**OFFERING:** RTTY audio converter Type CV-89A, and CM-22A comparator with manual; TS-497B signal generator, 2-400 MHz; I-177B valve tester and MX-949/U adaptor; AVO Multimeter; AN/URR-35C receiver. **WANTED:** APR-9A manual. (Enclose s.a.e. please).—Wright, 249 Sandy Lane, Hindley, Wigan (55948), Lancs.

**SELLING:** Webster "Bandspanner," £10; also mount and spring for it, quality made, £6. Webster mobile coils for 15 to 160m., brand new, also whip "Master Mobile" Micro-Z Match, Model 825, £5. Ultra Hi-Q mobile coils for 20m. and 75m., New-Tronics Model C.29-32, whip mounting and spring, brand new. Seco Model 520 Antenna Tester, £10. National HRO-60 cabinet and fittings (cost £40), £6. Grundig TK-55 recorder, perfect but surplus to requirements, £40. Johnson T/R switch, as new, £5. Heko transformer, rated 2 kW, pri. 230v. 8.69 amps, sec. 115v. 17-38 amp, 3.115 sockets, metal case, £5. All items plus carriage. Letters only, please.—Barnet, Box 10, Evesham, Worcs.

**FOR SALE:** Furzehill Oscilloscope, first class, £10. Variable voltage stabilised PSU, 500v. 200 mA, £10. Crystal controlled frequency meter, coverage 16 to 10.000 MHz (W.D. research equipment), offers?—Rawlinson, G8BJR, QTHR, or ring Charing (Kent) 2158.

**SALE:** Trio 9R-59DS, fitted 1 MHz calibrator and 150v. stabiliser, £40.—Williams, G3RSJ, QTHR or ring Pakenham (Suffolk) 30675.

**DISPOSING:** Complete station in fine condition—Hallicrafters SX-96 with crystal calibrator, K.W. Valiant Tx and factory PSU, with all accessories and spares. Reasonable offer accepted.—Warrington-Strong, ex-G2AC, May Cottage, Ripple, Tewkesbury, Glos. (Tel: Upton-on-Severn 2831).

**FOR SALE:** Heath Mohican Rx, with manual; little used since service by factory, Canadian Marconi 52 Set with manuals and lots of spare valves, £12, plus AC/DC PSU £5, or £15 the two. Buyers to collect.—Sharpe, G3UXU, Hemel Hempstead 54413.

**WANTED:** Trio 9R-59, Eddystone EC-10 or similar receiver; details, please.—Embrey, G3KNG, QTHR, or ring Codsall (Staffs) 3134.

**SALE:** K.W. Viceroy Tx, with extra half-lattice filter, £85. Also KW-77 receiver, £60. Both items good condition and excellent appearance. **WANTED:** HW-32A.—Crossan, 8A Beckenham Road, West Wickham, Kent. (01-777 6645).

**WANTED:** 4X500 without base. Also Eddystone dial.—McHenry, 2A Park Town, Oxford (0865 56321).

**OFFERING:** Drake solid-state SPR-4 communications receiver, virtually unused and in maker's packing, complete with crystal calibrator, noise blanker, 24 crystals, D.C. cord and speaker. Current value £420, offers around £350 invited.—Fletcher, 62 Moorbridge Lane, Stapleford, Nottingham. (Tel: Sandiacre 3446).

**The last few copies of a limited number of these titles specially imported from the States and not to be repeated.**

#### **BUILDING YOUR AMATEUR RADIO NOVICE STATION**

This book is the first "completely detailed" construction manual for building an amateur novice radio station. Nothing is overlooked in building the station from scratch to the actual on-the-air operation. The transmitter and receiver are distinctly professional in performance quality and appearance.

The book is primarily directed to the novice radio ham, it contains many novel and valuable construction hints and tips for amateurs in any licence class. As a finished touch to the projects a complete "rollaway" ham shack for hams with limited space (apartment dwellers, etc.) is featured and fully described.

By **W7OE**

£1.90

#### **HAM ANTENNA CONSTRUCTION PROJECTS**

Besides full details on many useful and interesting types of aeriels, Ham Antenna Construction Projects includes complete information on long-lasting construction methods, as well as how to position your antenna to achieve maximum distance with a given radiation pattern. In addition, much easy-to-understand technical information on tuning antennas and the use of test equipment is presented.

£2.10

#### **TRANSISTOR FUNDAMENTALS—Vol. III**

Covers circuits used in radio, audio and television equipment. It also introduces you to logical troubleshooting procedures used in locating defective parts or faulty adjustments in these circuits. This book will help you learn to repair many transistor circuits used in audio amplifiers, radio and television receivers.

£2.40

#### **RADIO CIRCUITS**

By **Thomas M. Adams**

This volume goes into great detail in explaining the action of the various circuits used in radio receivers—also voltage analysis and signal substitution methods for servicing typical valve and transistor receivers.

£1.80

*The above prices include postage and packing*

Available from

## **SHORT WAVE MAGAZINE**

Publication Dept.,

55 Victoria St., London SW1H 0HF

Telephone 01-222 5341

(Counter Service 9.30-5.15 Monday to Friday)

(Nearest Station: St. James's Park)

GIRO A/C. No. 547 6151

## **DON'T BUY A DIGITAL CLOCK**

UNTIL YOU HAVE SEEN OUR LEAFLET AND SPECIAL DISCOUNT PRICE LIST FOR RADIO AMATEURS and S.W. LISTENERS. (s.a.e. please). WE ARE YOUR SPECIALISTS, HAVE THE MOST COMPREHENSIVE AND LARGEST STOCKS, CHECK EVERY INDIVIDUAL CLOCK, AND ALWAYS DESPATCH BY RETURN.

### **Aero & General Supplies**

NANAIMO HOUSE, 2 RINGWOOD AVENUE,

LEEDS LS14 1AJ.

TEL. 658568

# DERWENT RADIO

5 COLUMBUS RAVINE, SCARBOROUGH. Tel. SCA 65996

Showroom open Tuesday/Thursday/Friday/Saturday

MEMBER OF THE AMATEUR RADIO RETAILERS ASSOCIATION

PLEASE ADD VAT TO ALL PRICES EXCEPT PUBLICATIONS

KW103 swr/power ...	£12.50	G Whip LF coils ...	£4.00
KW 2000E and A.C. p.s.u.	£210.00	Lafayette HA 600 ...	£50.00
KW Atlanta and p.s.u.	£140.00	Lafayette HA 800 ...	£57.00
KW 202 receiver ...	£140.00	Codar 12/RC ckt. unit ...	£2.50
KW 204 transmitter ...	£160.00	Codar Multiband 6 ...	£11.50
KW 107 AE match unit ...	£46.00	Wight traps standard ...	£2.75
KW EZ match ...	£16.50	Wight traps hi power ...	£3.75
KW 101 swr bridge ...	£8.20	Shure 201 microphones ...	£3.75
KW AB switch ...	£4.25	Shure 444 ...	£13.25
KW Balun ...	£1.95	Acos Mic 45 ...	£1.00
KW Atlanta VFO ...	£37.00	"J" Beam Halo ...	£1.35
Yaesu FR50B ...	£65.00	Boom mic crystal ...	£4.60
Yaesu FR400Dx ...	£175.00	Boom mic ceramic ...	£4.95
Yaesu FL50B ...	£75.00	4 digit impulse counter ...	10p
Yaesu FL400 ...	£165.00	10 Crystals our selection ...	65p
Yaesu FT 200 and p.s.u.	£190.00	50 resistors ...	16p
Yaesu FT101 ...	£280.00	14/16 DIL sockets ...	15p
Yaesu FT401 ...	£265.00	20 disc ceramics ...	15p
Unica UR1A Rx ...	£25.00	Bagle remote ckt. mic. ...	£1.65
Unica UNR30 Rx ...	£14.75	10 ceramic capacitors ...	10p
Transistor Rx. with 2M	£10.00	10 silver mica caps ...	7p
TE15 GDO ...	£12.50	Amphenol PL259 PTFE ...	30p
Henson swr bridge ...	£4.20	Amphenol SO239 PTFE ...	30p
Double meter swr ...	£7.75	Amphenol SO329 ...	25p
5 band AF meter ...	£4.00	Amphenol reducer ...	8p
Type 500 test meter ...	£8.85	10 0-1 Mfd caps 400v. ...	15p
Mini test meter ...	£10.00	Double sided copper clad ...	7p
Sentinel 2m. converter ...	£13.75	1N3819 ...	35p
Sentinel 4m. converter ...	£13.75	BC107, 108, 109 ...	10p
Sentinel 70cm. converter ...	£13.75	250 ohm carbon pots ...	25p
Sentinel 2m. pre-amp ...	£6.50	10 GSL strips (120 cards) ...	25p
Soldering irons from ...	£2.10	All RSGB publications stocked ...	10p
2 way intercom ...	£2.10	RSGB Callbook, post free ...	65p
"5" Dec ...	£1.00	Dosemeter ...	10p
AR22R ...	£25.00	10pfd variable ...	15p
3/6/7-5/9v. D.C. p.s.u.	£4.00	20pfd ...	15p
2000 ohm headset ...	90p	85pfd ...	15p
C40 cassettes ...	30p	100pfd ...	20p
6-20v. D.C. p.s.u. (1A stab)	£10.75	25pfd double bearing ...	20p
2 1/2" speaker 8 ohm ...	35p	30pfd double bearing ...	20p
3" speaker 8 ohm ...	40p	50pfd split stator ...	17p
5 mixed relays ...	50p	25pfd 2 gang ...	30p
6 BA bolts pack ...	10p	60pfd 2 gang ...	30p
6 BA nuts ...	10p	125pfd 2 gang large ...	60p
Pack 20 ICs with data ...	£1.00	500pfd 2 gang large ...	60p
Trio JR310 Rx ...	£75.00	4-5pfd pre-set ...	4p
Trio JR599 ...	£160.00	10pfd pre-set ...	5p
Trio 9R59DE ...	£49.00	3-20pfd pre-set ...	4p
Trio SP SD speaker ...	£4.50	10-40pfd pre-set ...	2p
Trio TX 399 transmitter ...	£160.00	10-120pfd pre-set ...	2p
RCA IC manual ...	98p	Mixed sleeving pack ...	30p
RCA Hobbies manual ...	76p	Mixed rotary switches ...	£1.00
RCA Valve manual ...	98p	Service head/mic. set ...	£1.30
RCA COS/MOS ...	98p	8 new relays ...	£1.00
G Whip tribander ...	£10.50	RCA 4067 ...	53p
G Whip 160/80cm ...	£9.00	RCA 3N140 and 141 ...	78p
G Whip 160 Ranger ...	£7.50	Pyc hi and lowband whips ...	40p
G Whip base mount ...	£1.45		

Second-hand equipment:		Trio 9R59DS ...	£42.00
KW Viceroy IV ...	£75.00	Trio JR300SE ...	£45.00
KW 2000A/B D.C. p.s.u.	£30.00	Codar CR70A ...	£22.00
Sommerkamp FL200B ...	£85.00	Codar 12/RC ...	£2.00
DF receiver 61044 ...	£40.00	Unica UR1A ...	£20.00
BC221 ...	£18.00	Fye hiband ranger ...	£8.00
Heath 5" scope ...	£50.00	Fye Vanguard hiband ...	£8.00
KW Pegmeter ...	£10.00	Swan 350 and p.s.u. ...	£160.00
Trio TS150 and p.s.u. ...	£155.00		

A good chance to stock up with top grade disc ceramic capacitors. Most values 2-2 pfd to .1 mfd, send 10p stamp for full lists and samples. 50p for stock parcel (post 6p).

We are looking for good condition modern transmitters and receivers etc. and will pay cash or give good trade in prices. Please let us have details with p.s.g. for offer. DES WOOD, G3HKO

PLEASE ADD EXTRA FOR CARRIAGE, S.A.E. FOR LISTS  
MAIL ORDER TO  
28 HILLCREST AVENUE, SCARBOROUGH, YO12 6RG  
(Telephone 63982)

## RADIO COMMUNICATION HANDBOOK

Fourth Edition of the Original RSGB "Amateur Radio Handbook"

Price £4.10

(Inclusive of post and packing)  
Available from stock

Order from

PUBLICATIONS DEPT.  
SHORT WAVE MAGAZINE LTD.  
55 VICTORIA STREET, LONDON, SW1H 0HF

## JUST ARRIVED:

### "RADIO HANDBOOK"

19th Edition, by Wm. Orr, W6SAI (974 pages). Price £7.50 at counter or £7.75 by post.

### "ARRL HANDBOOK"

1973 Edition (50th) of this Indispensable Radio Amateur manual, for so many years recognised as the "bible" in the Amateur Radio field. Price £2.85 (Limp Edition) or £3.65 (Buckram Edition).

Available from:

## PUBLICATIONS DEPT. SHORT WAVE MAGAZINE

55, VICTORIA STREET,  
LONDON, SW1H 0HF

## REG. WARD & CO. LTD.

(G2BSW)

WE ARE OFFICIALLY APPOINTED K.W. AGENTS FOR THE SOUTH WEST (Somerset, Dorset, Devon, Cornwall)

KW Atlanta with p.s.u.	£210.00
KW 2000B with p.s.u.	£240.00
KW 2000E TCVR. & A.C. p.s.u.	£265.00
KW 202 Receiver with matching speaker	£148.00
KW 204 Transmitter	£160.00
KW 1000 Linear	£135.00
KW 101 VSWR Meter (52 or 75 ohm)	£8.25
KW 103 VSWR Meter and Combined Power Meter	£12.50
KW E-Z Match, 10-80m. ATU	£16.50
KW 107 Combined E-Z Match, VSWR and R.F. Power Indicator, Dummy Load and Antenna Switch for 4 Outlets	£46.00
KW Trap Dipole 70' 75 ohm Twin Feeder	£18.50
KW Trap Dipole 97' Coaxial Feeder	£18.50
KW Trap Dipole with Balun	£18.50
KW 3-way Antenna Switches (for coax)	£4.25

YAESU FR50B Amateur Bands Receiver	£64.35
FT101 250w. Transceiver, with mic.; spkr. and built-in A.C./D.C. p.s.u.'s.	£246.00
FR50 + Cal. WWV	£68.31
FT200 Transceiver	£143.53
FP200 A.C. p.s.u.	£44.55
FR400SDX Rx. (with 160 and 2m.)	£172.80
SP400 Speaker	£10.89
Castrol 24 hour Digital Clocks	£7.42

EDDYSTONE RECEIVERS  
EC10 Mk. II £85.14; New Model 1000. £210.00.  
WE ARE THE DISTRIBUTORS OF EDDYSTONE PROFESSIONAL RECEIVERS FOR THE SOUTH WEST.  
SECOND HAND EQUIPMENT in stock: Trio JR500, £54.00; Atlanta Tcvt. and A.C. p.s.u. £172.80; KW2000A Tcvt., £128.70; Eddystone 640, £14.85; Eddystone 840C £39.60; Trio 9R59DS and spkr. (10 days use only), £44.10; Heathkit HW 100 Transceiver with new Shure Mic. A.C. p.s.u. and spkr. Ex-condition, £100.00.

SHURE MICROPHONES  
Model 444, £13.50; Model 201, £5.70.  
ANTENNAE 1-Beam 2 metre Beams in stock. Also Joustick and Joymatch A.T.U.'s, Stolle Ant. Rotators. 140ft. coils 14G. Copper Antenna Wire and Ribbed insulators.  
R.C.A. VALVES for KVV and Heathkit equipment, 6146, 6146B, 6HF5, 6LQ6, 6G6S, 6EA6, 6GWB, 6GK6, 6CM6, 6CL6, 6CB6, 6BNB, 6HS6, 6EW6, 12BA6, 12BE6, etc. and many other types.

TRADE INS WITH PLEASURE. OUR STOCK OF GOOD SECOND HAND EQUIPMENT CHANGES DAILY - LET US KNOW YOUR REQUIREMENTS.  
Due to currency fluctuations prices of imported equipment are liable to alteration. Add 10% VAT to all prices.  
WE STOCK R.S.G.B. PUBLICATIONS, LOG BOOKS, Etc.  
HP TERMS AVAILABLE CARRIAGE EXTRA ON ALL ITEMS  
AXMINSTER - DEVON Telephone: 3163

# INSIST ON VERSATOWER

Acclaimed as the World's leading telescopic tower in the field of radio communication. Models from 25' to 120'

Enquiries to Western Electronics (UK) Ltd Osborne Road, Totton, Southampton



Look for the name

**STRUMECH**

Strumech Engineering Co Ltd Coppice Side, Brownhills, Walsall, Staffs.

## G. W. M. RADIO LTD.

All prices include V.A.T. and post/carriage.

**TEST EQUIPMENT.** All standard mains

**OSCILLOSCOPES.** CT436 (Military version of Soloratron CD1014) D.C. to 6 mc/s., 10mV per cm. sensitivity. Double beam, £55. Soloratron 5335/2 (CT386A) D.C. to 10 mc/s, sensitivity 1mV per cm., £44. Miniature CT52, D.C. to 1 mc/s, restricted time base, 10 c/s. to 40 kc/s., but very useful, £22. Hartley 13A double beam, D.C. to 5.5 mc/s, but mains lead only, £22. Wattmeter absorption AF No. 1, 200 Micro-watts to 6 watts at impedances of 2.5 ohms to 20K, £11. Voltmeter valve No. 3 (TF958) 50 mV to 100v D.C., 100 mV to 150v. A.C., £22. BC221 Frequency Meters, complete charts and A.C. supply, £18-60 or less pack. £16-40. H.C.D. Research 5 mc/s. crystal standard. Complete unit for 24v. D.C. supply, temperature controlled and very accurate, £11. Crystal calibrators No. 10 made for Army 62 set, £2-10.

**POCKET DOSIMETERS.** 12 Dosimeters and one hand operated charger, £3.

**RECEIVERS TCS.** 1-5 to 12 mc/s. Power needed 12v. A.C. or D.C. and 220v. D.C., clean untested condition, £10-35.

**TRANSMITTER P.A. UNITS, STC T4189.** Tunes 2-8 to 18 mc/s, manual or 28v. motor driven. 13" x 8" x 8". Pair CV518 (4x150) 28v, blower cooled. Bases are NOT U.H.F. type. Ideal basis for linear amplifier construction, £8-75.

**PLESSEY PTR61.** 24v. 6 channel remote Transmitter/Receiver 116-132 mc/s. CV04-7 output, 6" x 8" x 11" weight 16 lbs. Good clean condition and complete with circuit and details of suggested 2 metre conversion and heater modification on 12v., £8-75.

**REDIFON 5SB Generator 6315/a,** 6 transistor plug in unit, 9" x 6" x 1 1/2". No details, £1-10.

**REED RELAYS** for G3FCW keyer and many other applications where a 5v. operated 4 normally off reed relay is required. 200 ohm coil, 16p each (plus 10p post for any number). Reed inserts 1.85" long (body 1-1/2" dia. 0.14". Gold clad contacts switch up to 500 ma at up to 250v. D.C. Normally open, 69p per dozen, £4-12 per 100, £30-25 per 1000, £275 per 10,000.

**EDDYSTONE RECEIVERS 730/4.** 480 kc/s. to 30 mc/s. Very clean, fully checked and in good working order, £65.

**METERS.** 500 microamp calibrated 0-1.4 Kilowatts by Ernest Turner—oblong 1 1/2" x 1 1/2" or 3" square. Either type, £1-35. **HYGROMETERS,** wet and dry type, centigrade, £1-35.

All Receivers and Test Equipment are in working order at time of dispatch. Carriage charges included are for England and Wales only.

Telephone 34897

Terms Cash with order. Early closing Wednesday.  
40-42 PORTLAND ROAD, WORTHING, SUSSEX

## VISIT LONDON'S LIGHTHOUSE

*our lighthouse keeper wants to meet you!*

Jim Roche has been Imhofs Eddystone lighthouse keeper for a good few years now - so who better than he to guide you into the right channel, for an Eddystone communications receiver:

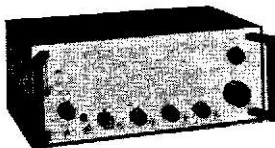

**Model 1001** - general-purpose receiver with reception facilities for CW, MCW, AM and SSB. Provision for crystal control on 10 channels.

EC10 Mk II still 'Top of the Pops' in the modest price range of communication receivers. Embodies features usually only found in the more expensive designs.

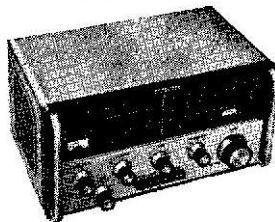

**IMHOFS**

112-116 New Oxford Street London WC1A 1HJ telephone 01-636 7878 RB1

## G3EKX S.S.B. PRODUCTS G3EKX

EDDYSTONE EC10, Mk. II	...	...	£86-00
EDDYSTONE 924. Power packs	...	...	£7-75
TRIO TRANSCEIVER. TS510/PS510. New	...	...	£180-00
TRIO YFO 5 (TS500)	...	...	£21-00
EDDYSTONE 898. Dials slightly soiled	...	ca.	£6-00
FURZEHILL. V.T.V.M. RF Probe. Mains I/P	...	...	£8-50
VICEROY Mk. 3A. TX - Power Unit	...	...	£55-00

Carriage extra please

**SPECIALY MATCHED VALVES FOR LONGER LIFE**

PAIR MATCHED 6HF5's. R.C.A.	...	(20p)	£5-50
PAIR MATCHED 6146 R.C.A.	...	(20p)	£5-00
PAIR MATCHED 6146B R.C.A.	...	(20p)	£6-20

**CRYSTALS.** New metal cased types. Mixed freq's from 201 kHz to 110 MHz. Please clearly state requirements and alternatives. Essential as s.a.e. is enclosed for reply. From ... (5p) ea. 60p  
10-230, 11-155, 1-450, 2-5, 10 245, 24 MHz. Spot On 26-508 ... (5p) ca. 75p

**SCARAB. S.S.B. Tx 1/2 lattice Filters.** All parts (3 xtal) inc. carrier xtal. instructions plus suitable 3 band S.S.B. Tx. cct. ... (21p) £8-99

**DYNAMIC. High/Low "Z" New Mics. DM18HL** ... £7-00  
DM16HL (30p) £6-00

**STABILISER VALVES.** New, boxed VR105/30 (20p) ea. 75p

**SEAFARER. Echo Sounders, latest, new. Mk. 3.** Bargain offer. Only ... (40p) ea. £29

**SUPERB R.C.A. ROTARY RELAYS.** 12v. D.C. input (hold in coil). Ideal for aerial switching-Co-ax 160m. to 2m. Changeover contacts. (3 sets). Only ... (24p) ea. 60p

1 FRANCES STREET, TRURO  
Tel. DEVORAN 882575 CORNWALL

# THE SENATOR CRYSTAL BANK

G3UGY

Phone 01-769 1639

**CRYSTALS FROM STOCK AT KEEN PRICES**

**SENATOR CRYSTALS: the first place to contact when you need good crystals quickly.**

Here are just a few of the popular frequencies actually in STOCK now:

kHz		MHz	
100 in HC13/U	£2.50	28.045 in HC25/U	£1.60
454 in HC6/U	£1.75	28.500 in HC25/U	£1.60
455 in HC6/U	£1.75	30.000 in HC6/U	£1.60
456 in HC6/U	£1.75	32.500 in HC18/U	£1.60
500 in HC6/U	£1.75	34.000 in HC18/U	£1.60
		34.500 in HC18/U	£1.75
		35.000 in HC18/U	£1.75
		38.666 in HC18/U*	£1.35
		40.000 in HC18/U	£1.60
		42.000 in HC18/U	£1.60
		70.000 in HC18/U*	£2.00
		71.000 in HC18/U	£1.75
		72.425 in HC18/U	£1.75
		72.500 in HC25/U	£1.75
		72.525 in HC18/U	£1.75
		96.000 in HC18/U	£2.00
		116.000 in HC18/U	£2.80

\* = Also in HC6/U

And here's our STOCK range of BRAND NEW HC6/U 8 MHz for 2M:  
 8-002 8-007 8-012 8-018 8-021 8-0266 8-032 8-041 8-043 8-047 8-048 8-0555  
 8-058 8-061 8-070 8-081 8-092 8-100 8-104 8-107.

All at £1.25 each, post free.

8-0555 MHz in HC6/U for TX x 18	=	145-000 MHz 2M Mobile	£1.25
44-7666 MHz in HC6/U for RX x 3	+ 10.7 MHz	=	145-000 MHz 2M Mobile £1.80
8-100 MHz in HC6/U for TX x 18	=	145-800 MHz for RAEN	£1.25
45-0333 MHz in HC6/U for RX x 3	+ 10.7 MHz	=	145-800 MHz for RAEN £1.80
12-975 MHz in HC6/U for RX x 12	= 10.7 MHz	=	145-000 MHz 2M Mobile £1.60
11-1916 MHz in HC6/U for RX x 12	+ 10.7 MHz	=	145-000 MHz 2M Mobile £1.60
12-0833 MHz in HC6/U for TX x 12	= 145-000 MHz 2M Mobile	£1.60	
8-7825 MHz in HC6/U for TX x 8	= 70-260 MHz 4M Mobile	£1.60	

**ANNUAL VACATION CLOSURE: JUNE 30 THRU JULY 30. NO DESPATCHES.**

**V.A.T. ADD 10% TO ALL PRICES.**

**Mail Order SENATOR CRYSTALS Dept. S.W., 36 Valleyfield Road, SW16 2HR**

29-780 MHz in HC6/U for RX x 2	+ 10.7 MHz	=	70-260 MHz 4M Mobile £1.65
6-74666 MHz in HC6/U for RX x 12	= 10.7 MHz	=	70-260 MHz 4M Mobile £1.60
11-710 MHz in HC6/U for TX x 6	= 70-260 MHz 4M Mobile	£1.60	

NEW FREQUENCIES FOR POPULAR CHANNELS:

44 593333 MHz in HC6/U for RX x 3	+ 10.7 MHz	=	144-480MHz F.M. Channel £1.80
45-016667 MHz in HC6/U for RX x 3	+ 10.7 MHz	=	145-750MHz Repeater Out £1.80
8-063888 MHz in HC6/U for TX x 18	=	145-150MHz Repeater In	£1.65
4-031944 MHz in HC6/U for TX x 36	=	145-150MHz Repeater In	£1.65
4-027777 MHz in HC6/U for TX x 36	=	145-000 Mobile	£1.65
4-013333 MHz in HC6/U for TX x 36	=	144-480MHz F.M. Channel	£1.65

NEW FREQUENCIES now available:

1 6202 MHz and 1-6184 MHz in HC6/U (spacing 1.8 kHz) at	£1.80 each
33-6666 MHz in HC6/U	£1.60
43 333 MHz in HC18/U	£1.70
46-666 MHz in HC18/U	£1.70
47-3333 MHz in HC18/U	£1.70
48-3333 MHz in HC18/U	£1.70
58-000 MHz in HC18/U	£1.70
10-866667 MHz in HC6/U	£1.70
9-975 MHz in HC6/U	£1.70

Prices for specially manufactured SENATOR Crystals are as follows (made to Ministry of Defense Standards):

50-149.9 kHz in HC13/U	£4.60
150-499 kHz in HC6/U	£3.85
450-500 kHz in HC6/U	£3.50
501-999 kHz in HC13/U	£4.50
1-000- 1.39 MHz in HC6/U	£3.20
1-40 - 20.00 MHz in HC6/U (18/U & 25/U over 5 MHz)	£2.00
20-00 - 59.99 MHz in HC6/U; HC18/U; HC25/U	£2.25
60-00 - 79.99 MHz in HC6/U; HC18/U; HC25/U	£2.50
80-00 - 114.00 MHz in HC6/U; HC18/U; HC25/U	£3.00
114-00 - 140.99 MHz in HC6/U; HC18/U; HC25/U	£7.00
141-00 - 175.99 MHz in HC6/U; HC18/U; HC25/U	£8.75
176-00 - 200.00 MHz in HC6/U; HC18/U; HC25/U	£12.00

PORTABLE PETROL ELECTRIC GENERATORS

## HONDA

Keen Prices to readers of Short Wave Magazine

**ALL MODELS, FROM THE INCREDIBLY QUIET HONDA E300E WHICH GENERATES 300 WATTS A.C. PLUS 12v D.C. AND MEASURES ONLY 13" x 12" x 9" TO THE HONDA E4000E, 4 KW DIESEL SET.**

For brochure & full details, call, write or phone  
 GODALMING 23279

**ASHLEY DUKES**  
 FARNCOMBE STREET, FARNCOMBE,  
 GODALMING, SURREY.

**WALKIE-TALKIE:** No. 88 ex-W.D. 14-valve four channel transmitter/receiver unit, £5.50 plus post/packing 68p. No. 19 ex-W.D. used transceiver, valved unit only, £5.50, carriage £1.10. No. 17 unit, used valved transceiver, 2v./120v., £3.10, post 60p. No. 38 Sets, 12v., dirty cases but new inside, ex-W.D., £5.50, post/packing 75p. Salvage telemeter unit, multi-valve receiver, speaker and tape unit, in sealed cartons, cost vast amount, £4.15, carriage 88p. Speech recorders, salvage Remington AC mains valved unit, cost vast money, £5.50, carriage 88p. Chart Boards, ex-W.D. A.M. type, for air speed, wind speed, distance, vernier calibrations, cost vast amount, £5.50, post/packing 68p. Ex-W.D. tank aerials, three 4-ft. top sections, 85p, post 28p. American ex-W.D. feather-weight low-resistance headphones, new, £1.65, post 15p. New No. 19 microphone and headphone sets, boxed, £2.75, postage 25p. Callers welcome.—

**SOUTHERN SURPLUS MERCHANTS, LTD.**

66 London Road, Kingston-upon-Thames, Surrey

(Tel.: 01-546 9263)

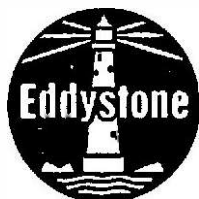

Your local  
**Eddystone dealer**  
is:

**CHESHIRE**  
The Transistor Centre  
(Wimslow) Ltd  
Green Lane  
Wimslow 24766  
**CORNWALL**  
R. V. Heming Ltd  
(Peter Heming G3WVB)  
Cliff Road, Newquay  
Newquay 2191  
**S.S.B. Products**  
(Norman Birkett G3EKX)  
1 Frances Street  
Truro  
Devoran 862575  
**DEVON**  
Reg. Ward & Co. Ltd: G2B5W  
Axminster  
Axminster 3163  
**ESSEX**  
F. E. Smith  
184 Moulsham Street  
Chelmsford  
Chelmsford 54594

**IRELAND**  
John F. MacMahon  
10, Church Street, Enniskillen  
Co. Fermanagh, N. Ireland  
Enniskillen 2955

**LANCASHIRE**  
Holdings Photo Audio Centre  
Mincing Lane - Darwen Street,  
Blackburn BB2 2AF  
Tel. 59595

## "LISTEN TO THE WORLD WITH EDDYSTONE"

Stephen-James Ltd  
70 Priory Road, Anfield  
Liverpool L4 2RZ  
051-263 7829  
North West Electrics  
769 Stockport Road  
Levenshulme, Manchester 19  
061-224 4911  
Croftfilm Ltd  
46 Fringate, Preston PRI-2AT  
Preston 53244

**LEICESTERSHIRE**  
A. K. Davey Ltd  
New Street, Hinckley  
Hinckley 2173 and 4288  
**LONDON**  
Amfols (Retail) Ltd  
112-116 New Oxford Street  
W.C.1  
01-636 7878

R. T. & I. Electronics Ltd  
Ashville Old Hall  
Ashville Road, Leyconstone, E.11  
01-539 4986  
Radio Shack Ltd  
188 Broadhurst Gardens  
London, N.W.6  
01-624 7174  
**NORTH UMBERLAND**  
Aitken Bros. & Company  
35 High Bridge  
Newcastle upon Tyne NE1 1EW  
Newcastle upon Tyne 26729

**WALES**  
Holt High Fidelity  
Picton Arcade, Swansea  
Swansea 53254  
Holt High Fidelity  
13 Portland Street, Swansea  
Swansea 41032

**WARWICKSHIRE**  
Chas. H. Young Ltd  
170/172 Corporation Street  
Birmingham 4  
021-236 1635

**MIDGET TUNING CONDENSERS** with Direct Drive. 125+125pf at 22p; 250+250pf at 23p; 500+500pf at 33p; 6pf at 11p. With S.M. Drive. 300+100pf at 33p; 300+300pf at 33p; 500+500+20+20pf at 33p.

10.7 MHz **CERAMIC FILTERS** at 27p with data.  
**SPECIAL EX-EQUIPMENT S.C.R.'s**, 400 PIV 5 amp. 3 for 55p. 7 for £1.10.

2000uf 30v.w. **CONDENSERS**, Size 2 1/2" x 1" at 16p ea.  
**VHF-UHF VARACTOR TUNING DIODES**, 80pf at 4 volt, 57pf at 8 volt usable up to 400 MHz untested, 6 for 27p.

400 PIV 5 amp. **TRIACS PRESS FIT** at 40p ea.  
**COMMUNICATION SERIES OF I.C.'s**, Untested consisting of 1 x R.F., 3 x I.F., 2 x VOGAD, 2 x AGC, 1 x Mike Amp, 2 x Double Balanced Modulators, 1 x Mixer. The 12 I.C.'s for £3. Separate I.C.'s at 27p ea.

50 PIV 1 amp **SILICON BRIDGE RECTIFIERS** at 27p ea.  
**PLASTIC 2N 3055 SILICON NPN 100 WATT POWER TRANSISTORS** at 44p each.

3/8" **COIL FORMERS** with core at 3 for 6p; 1/2" **COIL FORMERS** with core at 5p ea.  
**GENERAL PURPOSE I.C. AMPLIFIERS DC** to 15 MHz tested, 17p ea. Untested, 5 for 55p.

**HIGH SPEED DUAL COMPARATORS**, Type SL717 in I4 Lead DIL at 33p each with data.  
**RCA LOW NOISE 700 MHz NPN TRANSISTORS**, Type 2N S181 at 11p ea.

**SUB-MIN SOLID TANTALUM CONDENSERS**, 2.2uf 20v.w., 4.7uf 35v.w., 5uf 25v.w., 47uf 6v.w. All at 7p ea. 3 for 16p.

**MULLARD C280 Series of Miniature Polyester Condensers** 250v.e., -0.22uf, -0.68uf, 6 for 9p; -22uf, 47uf at 4p ea.

**MULLARD 8F710 FETS**, 27p ea. 4 for £1.  
**FT243 CRYSTALS**, 6200 kHz, 6317 kHz, 6400 kHz, 6525 kHz. All 11p ea.

**HC&U CRYSTALS**, 3250 kHz, 4250 kHz, 40,500 kHz. All at 11p ea.  
**100 SILICON ALLOY PNP TRANSISTORS** at 55p ea.

**600 MHZ MICRO ALLOY PNP TRANSISTORS**, Unmarked MSD39 at 5p ea., 44p doz.

1000pf **SOLDER-IN FEED THRO'S** at 16p doz.  
**SGS SILICON PNP TRANSISTORS W19476** like 2N3702, 8p ea., 12 for 55p.

**RADAR LIMITING WIDE BAND AMPLIFIERS**, 10 to 150 MHz. Untested with data, 11p each, 6 for 55p.

**WIMA POLYESTER CONDENSERS**, 4.7uf 250v. A.C. size 2 1/2" x 1 1/2" x 1 1/2" at 33p ea.

**ISKRA PRE-SET POTENTIOMETERS SUB-MINIATURE**, 2K type PN11B, 2.5K type PN11B, 5K type PN10B, 50K type PN11B, 100K type PN11B, Morganite Type 200K, 1 Meg. All 5p ea., 6 for 22p.

**PAINTON STUD SWITCHES**, 1 Pole 30 way 2 BANK at £1.10 ea.  
**SPECIAL 400 PIV 5 Amp S.C.R.** Mounted on Insulated Heat Sink can be mounted anywhere at 55p.

**DISCOIDAL FEED THRO'S**, 30pf at 20p doz.  
ALL PRICES INCLUDE V.A.T.

**J. BIRKETT** 25 THE STRAIT, LINCOLN,  
LN2 1JF. Telephone: 20767  
Radio Component Suppliers

**TRANSCIVERS.** Due to warehouse clearance we have for disposal, few only Transceivers No. 62 Mk. 2, made by Pye for the Navy and Army. Using a total of 11 valves, 1 RF and 2 I.F. stages, A.V.C., BFO, covering 1.5 Mc/s. to 10 Mc/s.

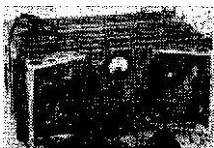

(approx. 200 to 30 metres) in two switched bands. Can be used on RT or CW M.O. or Crystal. A very good internal ATU made of a rotating silver wire coil, tunable over the complete range, suitable for aerials 4ft. to 100ft., internal P.U. for 12 volt D.C. A meter is fitted for checking voltages A.V.C., etc. Housed in a metal waterproof case, approx. size 18" x 10 1/2" x 12 1/2". Supplied in as new condition, being either re-built by Army Signals or store-soiled new set. In cartons two spare valves, circuit, price £17.50, carriage £2. Suitable hand telephone with spring coil plus transmitter switch in handle. Modern, £1.50.

**EDDYSTONE COMMUNICATIONS RECEIVER 730/4**, just released, BFO, AF Filter, Crystal Phasing, Variable switched Selectivity, Crystal Calibrator etc, 15 valves, A.C. Mains operated, Range 30 mc/s to 480 kc/s over 5 Bands. Price as received from Ministry, complete in good condition £47.50, or checked and tested £55 carr £2.50.

10% VAT. S.A.E. all enquiries.

Terms, Cash or Uncrossed P.O.

as same will be returned if out of stock.

**JOHNS RADIO**

424 BRADFORD ROAD,  
BATLEY, YORKS.  
Phone: BATLEY 7732

## SOLID-STATE RTTY CONVERTER-KEYER SRD-1

- COPIES 850/400/170 HZ SHIFTS
- BUILT-IN SINGLE AND DOUBLE CURRENT PSU
- F.S. KEYER FOR TX (AND OPTIONAL AFSK)

Complete and ready-to-go for send-receive RTTY with TX, RX and teleprinter.

- Advanced circuitry, 6 ICs, 25 semi-conductors. ● Input matches receiver outputs 3-8 or 500-600 ohms. ● 3-pole Butterworth input bandpass filter. ● Switched 850/400/170 Hz Amateur/Commercial shifts. ● 2-pole low-pass filter. ● Tuning meter. ● Monitor scope outputs. ● Mark Hold and Normal/Reverse shift switch. ● Built-in loop PSU—Instant switch-selection of single- or double-current printers. ● Narrow-shift CW identification. ● F.S. Keyer output for TX. ● Socket and circuitry already fitted for optional plug-in AFSK keyer module, 850/170 Hz. ● Manual. ● Two-tone pvc-coated case, 9" w x 3 3/8" x 14" d. Weight: 7 lbs SRD-1, £54.45.

(Optional plug-in AFSK module, SRD1-AK, £6.32. SRD-1 complete with SRD1-AK, £60.50).

**RTTY CONVERTER-KEYER** Model TTU, £132. **ST-5** PCBs and datasheets, £4.56. **TOROIDS** 88 mH, 82p per pair. **ST-6** PCBs and datasheets, £12.92. **ST-6 KIT** complete less case, with datasheets, £68.75. **SAMSON ETM-2b**, £26.18. **ETM-3b**, £28.54. **JUNKER** Precision hand key, £10.72. **BAUER** keying lever, £4.18. **SSB 90° AUDIO PHASE SHIFT NETWORKS**, £3.24. **PRINTSET** Basi-kits.

ALL PRICES INCLUDE V.A.T

All goods post-paid U.K. Send stamp for Catalogue SP5.

Annual Holiday - We shall be closed AUGUST 1st - 22nd

**SPACEMARK LTD.**  
THORNFIELD HOUSE, DELAMER ROAD,  
ALTRINCHAM, CHESHIRE.  
(Tel. 061-928 8458)

## CALL BOOKS

### INTERNATIONAL :

<b>RADIO AMATEUR CALL BOOKS (1973)</b>	
"DX Listings" . . . . .	£2.95
"U.S. Listings" . . . . .	£3.75
"G's" only 1973 . . . . .	70p

## MAPS

<b>AMATEUR RADIO MAP OF WORLD</b> Mercator Projection — Much DX Information — in colour. Second Edition . . . . .	65p
<b>DX ZONE MAP (GREAT CIRCLE)</b> In colour with Country/Prefix Supplement Revised to January 1972 . . . . .	85p
<b>RADIO AMATEUR MAP OF THE U.S.A. AND NORTH AMERICA</b> State boundaries and prefixes, size 24" by 30", paper . . . . .	60p
<b>RADIO AMATEUR'S WORLD ATLAS</b> In booklet form, Mercator projec- tion, for desk use. Gives Zones and Prefixes (New Edition). . . . .	£1.10

## LOG BOOKS

<b>Standard Log (New Glossy Cover)</b> . . . . .	55p
<b>Receiving Station Log</b> . . . . .	45p
<b>Minilog</b> . . . . .	25p

(The above prices include postage and packing).

## MORSE COURSES

### G3HSC Rhythm Method of Morse Tuition

*Complete Course with three 3 speed L.P. records with books	£4.50
*Beginner's Course with two 3 speed L.P. records with book .	£3.30
Single 12" L.P. Beginner's with book . . . . .	£2.75
Single, 12" L.P. Advanced with book . . . . .	£2.75
Three speed simulated GPO test. 7" d.s. E.P. record . . . . .	85p

Prices include postage, packing and insurance  
in U.K. only \*Overseas orders + £1.00.

Available from

## SHORT WAVE MAGAZINE

Publications Dept., 55 Victoria Street,  
London, SW1H 0HF . . . . . 01-222 5341

(Counter Service, 9.30-5.15, Mon. to Fri.)

(Nearest Station: St. James's Park)

(GIRO A/C No. 547 6151)

## RTTY TERMINAL UNIT

P. C. Boards for the Irvin Hoff ST-6 RTTY Demodulator  
(Ham Radio Jan./Feb. 1971, Wireless World Feb. 1973).  
Complete set of 8 boards in fibreglass, with 0-156"  
pitch gold-plated edge-connectors, covering 170  
and 850 Hz shift, with layout diagrams. These are high  
quality, professional standard boards at only £9.20  
per set (post paid). **Why pay more?**

### G3OUV,

"LOAKES HOUSE, LOAKES PARK,  
HIGH WYCOMBE, BUCKS. HP11 2JU

G8CKN



G8DGR

### BASE AND MOBILE ANTENNAS

4dB 2m.  $\frac{5}{8}$  whip ... .. £4.00 inc. V.A.T.  
4dB 2m.  $\frac{5}{8}$  Ground plane ... £7.75 inc. V.A.T.

## ANTEC

74 Upper Sherbourne Road, Basingstoke,  
Hants.

Tel. Basingstoke 27527

C.W.O.—P. & P. 50p—S.A.E. for catalogue

## TRIO For reliability &

value  
Short Wave  
and Hi-Fi

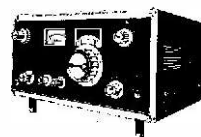

We have always thought it worth paying that little extra for  
the reliability that has been the characteristic of TRIO Hi-Fi  
and Short Wave equipment.

Now you don't pay any extra. Whilst competitors' prices soar,  
TRIO have managed to keep theirs down.

**JR.599.** A really beautiful mains or 12 volt battery ham  
band receiver. AM/FM/SSB/CW filters, 160 metre-2 metres  
ham band coverage, £175 inc. VAT. (Matching transmitter  
available at same price).

**TS.515/PS.515 Transceiver**—try it out for sensitivity  
on receive on 10 and 15 metres, or for selectivity on 40 metres.  
Out-performs most receivers. Uses real TX (not TV) valves,  
plus blower on P.A. Very conservatively rated at 180 watts  
P.E.P., £231 inc. VAT.

**JR.310.** Standard version at £82.50 inc. VAT or our super  
de luxe with top band plus many extra features at £93.50  
both fantastic value. Free RSGB Test Report on request.

**9R-59DS** at £54.45 inc. VAT. This is not just a toy but an  
ideal beginners general coverage receiver.

Delivery £3.30 via Securicor (our risk), £1.10 via Rail (your  
risk!).

ACCESS — SEND YOUR CARD NUMBER —  
WE SEND THE GOODS

## HOLDINGS PHOTO AUDIO CENTRE

39/41 MINCING LANE, BLACKBURN, BB2 2AF  
Telephone: 59595/6

# Technical Books and Manuals

(ENGLISH AND AMERICAN)

## AERIAL INFORMATION

ABC of Antennas . . . . .	90p
Aerials (By D. Sjobbema) . . . . .	88p
Aerial Handbook (Briggs) . . . . .	87p
Amateur Radio Antennas (Hooton) . . . . .	£1-87
Antenna Handbook, Volume 1 . . . . .	£1-77
Antenna Round-Up, Volume 1 . . . . .	£1-47
Antenna Round-Up, Volume 2 . . . . .	£1-77
Antenna Handbook, 12th Edition (ARRL) . . . . .	£1-40
Beam Antenna Handbook, 4th Edition . . . . .	£2-10
Quad Antennae, 2nd Edition . . . . .	£1-80
Simple Low Cost Wire Antennas . . . . .	£1-72
73 Vertical, Beam and Triangle Antennas (by E. M. Noll) . . . . .	£2-40
73 Dipole and Long-Wire Antennas (by E. M. Noll) . . . . .	£2-20

## BOOKS FOR THE BEGINNER

Amateur Radio (Rayer) . . . . .	£1-60
Beginners Guide to Radio (7th Edition) . . . . .	£1-12
Beginners Guide to Electronics (N.E.) . . . . .	O/P
Beginners Guide to Transistors . . . . .	£1-12
Beginners Guide to Colour TV . . . . .	£2-05
Better Short Wave Reception, 2nd Edition . . . . .	£1-80
Course in Radio Fundamentals (N.E.) . . . . .	£1-15
Foundations of Wireless and Electronics . . . . .	£2-02
Guide to Amateur Radio (N.E.) . . . . .	89p
Ham Radio (A beginner's Guide) by R. H. Warring . . . . .	£1-72
How to Become a Radio Amateur . . . . .	59p
Learning the RT Code . . . . .	27p
Morse Code for the Radio Amateur . . . . .	15p
Radio, by D. Gibson . . . . .	85p
Radio Amateur Examination Manual (N.E.) . . . . .	89p
Simple Short Wave Receivers (Data) . . . . .	89p
Understanding Amateur Radio . . . . .	£1-37

## GENERAL

ABC of Electronics (by Farl J. Waters) . . . . .	£1-20
ABC of FET's . . . . .	£1-35
ARRL Calculator, Type A . . . . .	92p
Easibinder (to hold 12 copies of Short Wave Magazine together), available end of August . . . . .	£1-05
FET Principles, Experiments and Projects . . . . .	£2-15
Guide to Broadcasting Stations (16th Edition) . . . . .	60p
Having Fun with Transistors . . . . .	£1-59
How to Listen to the World—7th Edition . . . . .	£1-80
Know Your Oscilloscope (by Paul C. Smith) . . . . .	£1-80
Microphones . . . . .	£1-65
Practical Integrated Circuits (Newnes-Butterworth) . . . . .	£1-01
Practical Transistor Theory . . . . .	£1-10
Practical Wireless Circuits . . . . .	£1-34
Prefix List of Countries . . . . .	23p
Radio Engineers Pocket Book (Newnes) (N.E.) . . . . .	£1-26
RCA Designer's Handbook (Solid State Power Circuits) . . . . .	£3-50
RCA Receiving Tubes Manual . . . . .	£1-77
RCA Transistor Thyristor and Diode Manual . . . . .	£1-75
RCA Transmitting Tubes . . . . .	£1-35
Shop and Shack Shortcuts . . . . .	£1-75
Single Sideband: Theory & Practice (by H. D. Hooton) . . . . .	£3-47
99 Ways to IMPROVE YOUR SHORT WAVE LISTENING . . . . .	£2-05
Telecommunications Pocket Book (T. L. Squires) . . . . .	£1-32

World Radio and TV Handbook 1973 Edition . . . . .	£3-00
110 Integrated Circuit Projects for the Home Constructor . . . . .	£1-30
49 Easy Transistor Projects . . . . .	£1-01
110 Semi-Conductors Projects for the Home Constructor (Iliffe) . . . . .	£1-30

## HANDBOOKS AND MANUALS

Amateur Radio DX Handbook . . . . .	£2-17
Electronic Circuit Handbook, Vol. 1 . . . . .	£1-42
Electronic Circuit Handbook, Vol. 2 . . . . .	£1-42
New RTTY Handbook . . . . .	£1-80
Radio Amateur Handbook 1973 (ARRL) . . . . .	£2-85
Radio Amateur Handbook 1973 (ARRL) (Hard Cover) . . . . .	£3-85
Radio & Electronic Handbook . . . . .	£1-32
Radio Amateur Operators Handbook, 12th Edition . . . . .	53p
Radio Communication Handbook (RSGB) . . . . .	£4-10
Rtty A-Z (CQ Tech. Series) . . . . .	£2-25
Radio Handbook (W. I. Orr) 19th Edit. . . . .	£7-75
Surplus Conversion Handbook . . . . .	£1-37
Television Interference Manual (G3JGO) . . . . .	90p
Transistor Substitution Handbook No. 10 . . . . .	£1-12

## USEFUL REFERENCE BOOKS

Amateur Radio SSB Guide . . . . .	£1-59
Amateur Radio Techniques—4th Edition . . . . .	£1-80
Care & Feeding of Power Grid Tubes (Elmac Division of Varian) . . . . .	£1-60
Engineers' Pocket Book—6th Edition . . . . .	£1-48
Guide to Amateur Radio . . . . .	50p
'G' Call Book 1973 . . . . .	70p
Hams' Interpreter . . . . .	63p
Hints and Kinks, Vol. 8 (ARRL) . . . . .	62p
Operating an Amateur Radio Stat. . . . .	O/P
Radio Amateur Examination Manual (N.E.) . . . . .	89p
Radio Data Reference Book (3rd Edition) . . . . .	£1-00
Radio, Valve and Transistor Data (Iliffe), 9th Edition . . . . .	89p
Service Valve and Semiconductors Equivalents . . . . .	35p
Single Sideband for the Radio Amateur (ARRL), 5th Edition . . . . .	£1-67
Single Sideband (Theory & Practice) by H. D. Hooton . . . . .	£3-47
Sun, Earth and Radio by J. A. Ratcliffe . . . . .	91p
Surplus Schematics (CQ) . . . . .	£1-22
Transistor Pocket Book . . . . .	£1-57

## TRANSISTOR MANUALS

ABC of Transistors . . . . .	£1-33
Field Effect Transistors (Mullard) . . . . .	£1-95
Having Fun with Transistors . . . . .	£1-59
Handbook of Transistor Circuits . . . . .	£2-35
Transistor Audio & Radio Circuits (Mullard) . . . . .	£1-96
Transistor Fundamentals: Basic Semi-Conductor and Circuit Principles, Vol. 1 . . . . .	£1-82
Transistor Fundamentals: Basic Transistor Circuits, Vol. 2 . . . . .	£1-92
Transistor Substitution Handbook, No. 12 . . . . .	£1-50

## VHF PUBLICATIONS

VHF Handbook, Wm. I. Orr . . . . .	£1-79
VHF Manual (ARRL) . . . . .	£1-37
VHF/UHF Manual (RSGB) (N.E.) . . . . .	£1-80

O/P (out of print)

The above prices include postage and packing.

Many of these titles are American in origin.

Available from

Publication Dept., 55 Victoria St., London SW1H 0HF

(Counter Service. 9.30-5.15. Mon. to Fri.)

(GIRO A/C. No. 547 6151)

**SHORT WAVE MAGAZINE**

01-222 5341

(Nearest Station: St. James's Park)





# become a RADIO-AMATEUR!

learn how to become a radio-amateur  
in contact with the whole world. We give  
skilled preparation for the G.P.O. licence

**free!**

Brochure, without obligation to. SWB-73

**BRITISH NATIONAL RADIO & ELECTRONICS  
SCHOOL P.O. BOX 156, JERSEY, CHANNEL ISLANDS**

NAME: \_\_\_\_\_

ADDRESS: \_\_\_\_\_

BLOCK CAPS please

## T.M.P. (Electronic Supplies)

Exclusive agent in U.K. for Unadilla Radiation Products  
manufacturers of W2AU baluns and Quad hardware.

Excelsior Springs Electronic Laboratories  
suppliers of toroid cores and kits,  
Also

Electro-Voice communications range of microphones.

For further details write for illustrated leaflets and lists  
on other items, enclosing s.a.e. to admin address:

**3 Bryn Clyd, Leeswood, Mold.  
Flintshire. CH7 4RU.**

### New Goods—Prices include V.A.T. and postage:

- 4½" 30 Ω Loudspeakers, 55p.
- 4 core Curly Telephone Leads, extends to 3ft., 16p.
- Small Xtal Ovens, 6v./12v., takes 2 min. xtals, 40p.
- Min. Mains Xformers: 6v.—0-6v. 100 mA, 65p
- 12v.—0-12v. 100 mA, 65p.
- Standard ditto . 24v.—0-24v. 400 mA, £1.10.
- 0-9v., 0-9v. 1 amp., £1.20.
- D.C. Meters . 500µA 2" round, sealed, 95p
- 75 volts 2½" round, 75p
- 7-5 amp., 2½" round, 75p
- 3 amp or 2 amp 1½" square plastic, 50p.

One only, New FT101 with Top Band mod data, £2.49 to clear.

### Second-hand:

- T.D.M.S. 58V3 for T/P setting up, £16-50.
- Boonton Inductance Bridge. 0-10k microhenrys, £18-50.
- 300 Wave Guide Diodes. Ordinary or coaxial, 15p or £1 doz.

## ELEY ELECTRONICS

**112, GROBY ROAD, GLENFIELD, LEICESTER**

**G3ACQ OFFERS: FOR THE V.H.F. MEN. CRYSTALS:**  
6-9-16-35-36-70-80 MHz, 75p each, post paid. Bantax—J. Beam  
—Rotors—S.W. Bridges—**SOLID STATE MODULES** 2-4-  
70 cm. converters. These are very highly recommended and we  
can say without doubt there is none better at any price. We also  
keep D.C. band equipment such as: **TRIO—YAESU MUSEN—  
HY-GAIN AERIALS**, etc.

## S. MAY (Leicester) LTD.

**12/14 CHURCHGATE, CITY CENTRE,  
LEICESTER LE1 4AJ**  
Telephone 58662

## GUIDE TO BROADCASTING STATIONS

16th Edition

Hiffe & Son Ltd. 160 pages 60p (inclusive of p. & p.)

### CONTENTS

Long- and Medium-Wave European Stations: Some L.W. and M.W.  
Stations outside Europe: Short-Wave Stations of the World. Stations  
outside Europe: Short-Wave Stations of the World: European Standard  
Frequency Transmitters: Short Waves Broadcasting Bands: Wavelength  
and Frequency Conversion: European Television Stations: European  
VHF Sound Broadcasting Stations: Internationally Allocated Call  
Signs.

Available from stock:

PUBLICATIONS DEPT.

**SHORT WAVE MAGAZINE**

55 VICTORIA STREET, LONDON, SW1H 0HF

# FREE TO ENGINEERS



Whatever your age or experience you must read New Opportunities.  
It describes the easiest way to pass A.M.S.E., A.M.I.M.I., City &  
Guilds (all branches), Gen. Cert., etc., and gives details of courses  
in all branches of engineering Mechanics, Electrical, Civil, Auto,  
Aero, Radio, TV, Building, etc. You must read this book.

Send for your copy today—FREE!

B.L.E.T., BSW07 (CX), Aldermaston Court, Reading, RG7 4PF

Accredited by the Council for the  
Accreditation of Correspondence Colleges

## BRITISH INSTITUTE OF ENGINEERING TECHNOLOGY

# MORSE MADE EASY !!!

**FACT NOT FICTION.** If you start RIGHT you will be reading  
amateur and commercial Morse within a month. (Normal progress  
to be expected.)

Using scientifically prepared 3-speed records you automatically  
learn to recognise the code RHYTHM without translating. You  
can't help it, it's as easy as learning a tune. 18-W.P.M. in 4 weeks  
guaranteed. For Complete Course 3 Records & Books send £4.50  
(overseas £1 Extra).

For further details of course Ring 01-660 2896/01-668 3255 or  
send 4p stamp for explanatory booklet to:—  
GJHSC (Box 14) 45 GREEN LANE, PURLEY, SURREY

## 2 METRE CONVERTERS

LOW NOISE R.F. STAGE F.E.T. MIXER. Xtal controlled multiplier  
chain. Aluminium case. Size: 4" x 3" x 1½". I.F.'s 4-6, 18-20,  
24-26, 28-30 MHz, £11-55 each.

2 METRE LOW NOISE CASCODED F.E.T. PRE-AMPS. Aluminium  
case. Size: 2½" x 1½" x 1½", £5-50 each.

## E & E SERVICES

72 ELMSTONE ROAD, RAINHAM, KENT.

## SOME TITLES FROM FOULSHAM-SAMS

### ABC's of ANTENNAS

The introductory chapters cover the fundamentals of radio-wave propagation and basic antenna characteristics. The remainder of the book is then devoted to a discussion of the various types of antennas and their uses. Antennas for radio, television and two-way communications are included. Business radio, amateur, both mobile and fixed-station operation, are covered. The final chapter should be particularly appealing to those interested in microwave uses and radio-navigational systems. A perusal of this book will provide any student with an excellent foundation for more advanced study in antenna design.

89p

### AMATEUR RADIO SSB GUIDE

Single-sideband receivers, transmitters, and transceivers are now available which have higher frequency stability and are much easier to tune than the early models. In this book, the author presents a guide to single-sideband and single-sideband equipment, which will be useful to any amateur considering or already operating SSB

By W6TYH

£1.59

### BEGINNER'S GUIDE TO RADIO

For many years "Beginner's Guide to Radio" has been extremely popular as an introduction to the subject of radio-and-how-it-works. The many advances made in recent times have rendered a new edition necessary.

This seventh edition has been completely rewritten and brought up-to-date to take account of the latest techniques and methods, and covers every aspect of the modern radio scene, while including the important basic information necessary for the newcomer to the subject. The reader is guided from the first principles of electricity and magnetism, through radio waves, modulation and radio components, including valves and transistors, taking in radio transmitters and stereo broadcasting, and ending with hi-fi reproduction.

The book will be of interest to all who wish to understand the how-and-why of radio, whether it be for a hobby or a profession.

Seventh Edition

£1.12

### RADIO AMATEUR OPERATOR'S HANDBOOK

The opportunity has been taken of bringing this edition—the twelfth—right up-to-date and of incorporating extensive revisions. The book covers in detail the Post Office regulations governing the issue of transmitting licences.

The purpose of this Handbook is to provide all the information which the operator of a radio station may need about such matters as Country Prefixes, Call Sign Areas, Frequency Allocations, Standard Frequency Transmissions, Time Factors, Distance Tables, and so on. For the newcomer, this manual enables him to find the basic answers and to obtain the maximum pleasure from his hobby.

53p

### TRANSISTOR FUNDAMENTALS Vol. 1

This book is a carefully planned programmed introduction to semi-conductors and the basic electrical circuits. It begins with a brief description of transistors and later devotes an entire chapter to an explanation of transistor principles. Sandwiched between these chapters are explanations of voltage, current, and resistance; and the all-important Ohm's Law and Kirchhoff's laws. The book also looks at the more complicated nature of inductance, capacitance, and resistance in AC circuits.

£1.92

### TRANSISTOR FUNDAMENTALS Vol. 2

This volume describes transistors and how they are used in semi-conductor circuits. Simple circuits illustrate the basic principles involved, and the more complicated circuits found in amplifiers and oscillators help to show how the basic operations are applied. Later, some recent semi-conductor developments are discussed. Detailed descriptions of four new transistor devices are given and how they are being used.

£1.92

### KNOW YOUR OSCILLOSCOPE

By Paul C. Smith

The oscilloscope provides you with a "third eye" which lets you see what is actually happening in electronic circuits. But you must know something of the nature of this valuable instrument, and how to use it, before it will serve you. This book presents complete information on the circuitry, functions, and applications of the oscilloscope in easy-to-understand language. Worthwhile reading for anyone who uses an oscilloscope... a "must" for service technicians and students.

£1.80

Most Books described here are American in origin.

The above prices include postage & packing.

Delivery is from stock.

**Available from** **SHORT WAVE MAGAZINE**  
**Publications Dept., 55 Victoria St., London S.W.1. . 01-222 5341**  
 (Counter Service, 9.30-5.15, Mon. to Fri.) (Nearest Station: St. James's Park)

(GIRO A/C. No. 547 6151)

### PRACTICAL INTEGRATED CIRCUITS

This is the first British book to be published on micro-electronics for the amateur experimenter. With circuit diagrams, layouts and easy instructions, it shows how to construct ten practical radio and electronic devices using integrated circuits (IC's) which are now available at low cost from many component stores. Micro-electronics—the big development in electronics since the transistor—involve complex circuits in the form of tiny "chips", incorporating several circuit elements, to which it is only necessary to make connections. Various kinds of micro-circuits are already available to amateurs, with new ones regularly coming on to the market. In this book the authors provide, in addition to practical projects, an introduction which shows clearly the present state of the art and a summary of the items available commercially. The advent of the integrated circuit (IC) opens up a fascinating new field for the electronics student, constructor and experimenter. This book shows how to get started and produce some really interesting and worthwhile equipment.

£1.01

### HANDBOOK OF TRANSISTOR CIRCUITS

By Allan Lytel

Here is a collection of more than 200 practical transistorised circuits for use in counters, power controls, timers, indicators, photoelectric devices, power regulators, amplifiers, power supplies, oscillators, power converters, and other applications. Schematic diagrams, parts lists and descriptions of operation are included for each circuit.

Planned as a supplement and companion volume to Lytel's previous book, "Transistor Circuit Manual", many of the circuits employ such specialised semi-conductor devices as silicon-controlled rectifiers, photocells, zener diodes, and tunnel diodes, in addition to standard diodes and transistors.

This book is a handy source of information on the design, operation, and application of a wide variety of transistorised circuits. Engineers, technicians, students, and hobbyists will all find the circuits of interest and the material of value in research, development, experiment, and general studies of circuitry.

£2.35

### PRACTICAL WIRELESS CIRCUITS

There are more than 50 different circuits detailed in this book. Transistor receivers, 22 in all, range from an ultra-simple crystal diode circuit to a very sophisticated 10-transistor communications Rx. Valve receivers cover MW, SW and FM. Transistor and valve amplifiers include preamplifier, PA and Stereo.

There is a chapter on transmitters and transceivers, and another on transmitter and receiver circuits for Model Control. Circuits for an extensive range of Test Gear cover everything from a simple Transistor Tester to a Comprehensive Multimeter, including a Pockec Signal Tracer (RF, AF and IF), also FM, Square-Wave and Noise Generators.

Among the special circuits are a recording level meter for tape recorders, an electronic photographic timer and a solar cell receiver.

The first few simple circuits are accompanied by step-by-step instructions to enable the absolute beginner to gain enough experience with circuitry building to tackle the more complicated work.

£1.34

### 49 EASY TRANSISTOR PROJECTS

This book is for the electronic hobbyist who is interested in developing projects that can be fun as well as useful. Most projects can be constructed in one evening using only a few inexpensive parts. Many of the parts can be salvaged from old radio and television chassis.

Each project is presented in an easy-to-understand way, with a parts list and a schematic diagram. Many value substitutions can be made in resistors and capacitors without affecting the end result, providing that the proper transistors, coils, and transformers are used.

Projects in this book, which include an AM radio, an FM receiver, light relay controls, audio amplifiers, code practice oscillators and test equipment—each designed with only two transistor types.

£1.01

### 110 SEMICONDUCTOR PROJECTS

Due to the rapid advances in semiconductor technology, many engineers and certainly most amateurs have found it impossible to keep track of the new devices that become available because of lack of readable information. This book introduces the reader to such outstandingly useful new devices as the field-effect transistor, uni-junction transistors, silicon controlled-rectifiers, silicon planar transistors and integrated circuits, giving their properties and methods of operation, with full constructional details of many exceptionally useful circuits.

Of particular interest to the amateur are simple amplifiers, lamp and relay driving circuits, electronic switches—operated by light, sound or contact with water—and delay circuits ranging from a fraction of a second to 35 minutes. Among the many circuits which will be of interest to the practising engineer are amplifiers with input impedance as high as 500 megohms, voltage and current regulators, waveform generators, analogue-to-digital converters and logic circuits. All circuits are designed around internationally available semiconductors.

124 pages, including 110 illustrations

£1.37

## MORE BOOKS DESCRIBED

### RADIO AND ELECTRONIC HANDBOOK by G. R. Wilding

Technicians and service engineers in the Radio and Electronics industry require a considerable amount of data which is spread over many books. It is often difficult and time consuming to locate in a hurry. Students, however, who may have to study a whole series of course-books will find a condensation of such information, which gets down to the essentials, extremely useful. *Radio & Electronic Handbook* has been designed to provide, on the one hand, a reference book and, on the other, a revision guide.

The intention has been to summarise basic electronics into four separate, easily assimilated sections, which will provide rapid reference to important principles, formulae and applications. These four main sections are: Direct current theory; Alternating current theory; Valve theory and applications; and Transistor theory and applications. Practical worked examples and circuits diagrams have also been utilised whenever necessary.

The concise presentation, which covers all the relevant ground, makes for easy learning and the book should prove invaluable for both practical and examination requirements. **£1.28**  
149 pages including 84 diagrams.

### QUESTIONS AND ANSWERS ON RADIO AND TV 3rd Edition

#### PREFACE

Curiosity is the keystone of learning. The man who "wants to know" has a far better chance of digesting and retaining information than he who ploughs through a set subject simply because it has been put before him.

Hence the "Question and Answer" form of this little book. Wherever possible, the questions have been arranged to follow the growth pattern of information. Questions arise from the previous answers. This means that the book differs from a standard textbook in that subjects are not cajoled neatly into place; except that main chapter headings give a guide to the line of questioning, the reader can treat these pages as bedside or benchside reading. Mathematics and unwieldy formulae have been avoided. Circuits and other diagrams give the basic information and confusing frills are omitted.

There are many textbooks to which the reader who wishes to augment the information given here can resort. These chapters will whet his curiosity **83p**

### PRINCIPLES OF AERIAL DESIGN

by H. Page

The principles involved in the design of aeriels are by no means easy for the student to assimilate because they require a knowledge of field theory, which involves more difficult concepts than the more familiar circuit theory. In an endeavour to be precise and exhaustive it is all too easy to complicate the treatment, and so become involved in a welter of abstruse mathematics. On the other hand, if the subject is over-simplified the treatment can easily become purely descriptive, at the expense of an understanding of the principles involved.

In this book—which is not exclusively of amateur-band interest but more on Aerial Theory for the general reader—the author attempts to steer a middle course between these two extremes. The theory of aeriels is developed from first principles, but where approximations are necessary in order to avoid mathematical complication the reasons are given and the significance of the approximations indicated. By this means the reader is given a succinct introduction to the more important aspects of the theory of aeriels while the practical forms used in the frequency bands up to 30 MHz are also briefly described.

It opens with an exposition of the laws governing electric and magnetic phenomena upon the basis of field theory, and the fundamental concepts and quantities are introduced and defined. The theory and practical applications of Maxwell's electro-magnetic wave equations are next dealt with (and there is an appendix which gives the derivation of the vector formulae employed). The next chapter is concerned mainly with the two important characteristics of an aerial for transmission or reception—the radiation pattern and the impedance—while the final chapter describes the practical forms which aeriels take for particular uses and the various techniques employed to obtain the best effect.

The author has been employed for many years in the Research Department of the British Broadcasting Corporation; he also gives a post-graduate course of lectures on Aerials and Propagation in the Electrical Engineering Department of Imperial College, London. His book is as much for the seriously interested amateur as for the professional. 172 pages, including 96 text diagrams, plus 6 pages of art plates. **£1.35**

American & English Books.

The above prices includes postage and packing.

### 110 INTEGRATED CIRCUITS PROJECTS FOR THE HOME CONSTRUCTOR

Integrated Circuits are the most important new semiconductor devices to have been developed within the past decade. They are compact, easy to use and less expensive than their discreet transistor-resistor equivalents. This volume gives an entirely practical introduction to these devices by describing one hundred and ten constructional projects in which they can be used.

The projects range from simple low-level amplifiers to complex test equipment and include a number of hi-fi circuits and logic circuits. The integrated circuits used are internationally available types and all the projects have been designed, built and fully evaluated. The book should prove to be of practical interest to the professional engineer, the student and the amateur. **£1.30**

### INTEGRATED CIRCUIT POCKET BOOK by R. G. Hibberd

This book is a logical companion to the Authors' previous book—*The Transistor Pocket Book*, and is intended primarily for technicians and students whose courses include semi-conductors devices, but it will also be of interest to all those who are concerned with integrated circuits and their applications. **£2.60**

### DICTIONARY OF TELECOMMUNICATIONS

R. A. Bones, B.Sc., Ph.D., ACIS, CEng., MIEE, AInstP.

Economic growth throughout the world is closely linked with the development and growth of telecommunication systems. Modern industry demands ever-improving facilities for its executives to be able to speak to each other from opposite sides of the globe; to be able to transmit drawings, documents and pictures rapidly over large distances; and now to be able to send data accurately and quickly from computer to computer.

Telecommunications is an industry with a high growth rate and, like all technologically based industries, a new language has developed: a language which grows daily as new materials, techniques and systems are developing. This dictionary is an attempt to document that language.

The wide range of definitions, including many reproduced from, or based on, British Standards recommendations, is supplemented by appendices including units and abbreviations, wavelengths and frequency bands, and signal reporting codes.

The concise explanations of the terms in use should prove valuable to engineers, students, technicians, and to all whose work or interest requires them to understand modern telecommunication terminology. **£2.35**

### MICROPHONES

by A. E. Robertson

A general treatment, in twelve chapters with appendices.

**£1.40**

### WIRE ANTENNAS FOR RADIO AMATEURS

by W. I. Orr

What this Handbook contains:—How to build tested wire antennae (for two metres to 160m.—Top Band) that really get out—horizontals, verticals, beams, trap antennae, ground planes, etc. "Invisible" aeriels for amateurs in flats and other locations where radio and TV antennae are "prohibited."

Exact dimensions in feet and inches—also in metres and centimetres—for every antenna described—no guesswork!

How to build two "all-purpose" aerial tuners with 100 uses!

The truth about baluns. How to build an efficient, inexpensive balun for optimum antenna performance and accurate SWR readings.

The construction of 2, 3, 4 and 5-band trap dipoles. How to make your own efficient traps and save real money.

Three-band dipole for 80, 40 and 15 metres—only one feedline!

Ground plane aeriels for VHF and 10, 15, 20 and 40 metres.

High-gain beam antennae especially suited for VHF FM.

The efficient "folded Marconi" antenna for 40, 80 or 160 metres.

Clear explanations of resonance, radiation resistance, impedance, standing wave ratio (SWR), balanced and unbalanced aeriels.

Plus—radial wire ground systems; lightning protection; wood masts; counterweights; the easy way to use coax connectors—and much more!

This book is an American publication by a well-known author in the field of Amateur Radio. **£1.72**

Available from

Publication Dept., 55 Victoria St., London SW1H 0HF

(Counter Service, 9.30-5.15, Mon. to Fri.)

SHORT WAVE MAGAZINE

01-222 5341

(Nearest Station: St. James's Park)

(GIRO A/C. No. 547 6151)

# P. & P. DEVELOPMENTS

**Havant 72657**  
Shop Hours

WE SPECIALISE IN VHF EQUIPMENT  
FOR THE PROFESSIONAL AND AMATEUR!

**Cosham 74695**  
Evenings, Weekends

**MURPHY 821.** High band AM/TX/RX QQV03-10 final and driver stages, easily converted to two metres. . . . . £9, carr. 85p

**MURPHY 820.** Mid band dash version of the 821. Good condition. Will convert to two or four metres. . . . . £6, carr. 85p

**MURPHY 807.** High power AM mobiles for 2 or 4 metres. Less QQV03-20A and QQV03-10, but otherwise complete. . . . . £6, carr. £1

**MURPHY HIGH BAND RX.** Ideal for converting to two metre base receiver. Good condition p.s.u. included. . . . . £8-50, carr. £1-50

**REDUCED.** Cossor CC15 low band AM Mobiles QQV03-20A in final, complete with all leads, speakers mic, etc. . . . . £14-50, carr. £1-25

**PYE HIGH BAND.** AM Monitor receiver, four channels, ideal for conversion to two metre base RX. Very clean condition. . . . . £32-50, carr. £1

**PLESSEY PV215.** High quality SSB/DSB/AM/ISB driver units. Output frequency 100 kHz. Can be operated independently on USB and LSB at same time. Output level via 0/6dB atten. LC type filters, superb external ovens. These units are completely transistorised and in mint condition. Not just useless junk, but a superb basis to a side band station that would please even the most critical user, a real bargain. . . . . £20, carr. £2

**PLESSEY PVT 223A.** This unit will accept the hundred kHz above and mix giving output on 3.1 MHz. High quality mixer unit, giving an output useful for conversion up to VHF side band. Listen to 145.41 and hear the increased activity. Try 2 metres and start with real quality. . . . . £10, carr. £1-25

**RADIO ALARMS.** New Murphy Radio Alarm Units containing 12 volts p.s.u. audio board multi programme cam unit. Ideal for host of spares or as radio alarm. . . . . £1-50, carr. £1-25

**HF VFO/PA.** Contains 2 x 4X150A's chimney and blower. Good condition. . . . . £12, carr. 85p

**MULLARD** tubular ceramic trimmers 0-6pF, 15p; 0-10pF, 19p

**INVERTER P.S.U.** Ideal for making your equipment mobile. 24v. D.C. input 425v. D.C. at 125 watts output. New. . . . . £3, carr. 50p

**LOW VOLTAGE RELAYS.** G.P.O. Type 3000. 12 and 24v, 2 x C/O. 50p each, carr. 10p

**MIC INSERTS.** Dynamic and Carbon . . . . . 25p each, carr. 10p  
Lustrephone Dynamic . . . . . 75p each, carr. 15p

**STC 633.** High Band AM 12½ kHz Mobile . . . . . £45, carr. £1  
(Up to latest G.P.O. requirements will put on channel if required at small charge.)

**DIECAST BOXES.** 11" x 7" x 2". Containing transistor VHF aerial amplifier and edgewise battery level meter. New £1, carr. 25p

**PLESSEY PTR61E.** VHF TX/RX. Covers 116 MHz-132 MHz 12v. Operation 3 watts output, ideal start on 2 metres . . . . . £5, carr. £1

PLEASE ADD 10% FOR V.A.T. TO ALL PRICES  
TRADE ENQUIRIES WELCOME

G8DBX

19 LONE VALLEY, WIDLEY, COSHAM,  
PORTSMOUTH, HANTS.

## WORLD RADIO/TV HANDBOOK 1973

The World's only complete reference guide to International Radio & Television Broadcasting Stations. It includes: Frequencies, time schedules, announcements, personnel, slogans, interval signals and much more besides of value to the listener.

Lists all International short-wave stations, including frequencies, for each country; foreign broadcasts, long and medium wave stations (AM broadcast Band), TV stations and domestic programmes. Long recognised as the established authority by broadcasters and listeners. It is the only publication that enables you to identify BC stations quickly and easily. Enables you to fill more pages in your log book on the SW BC bands and helps you add more BC-station QSL cards to your collection.

£3.00

(The above price includes postage  
and packing).

from:

**SHORT WAVE MAGAZINE**  
55 Victoria Street, London, SW1H 0HF

## CALLBOOK

(1973)

The "Call Book" proper is now published only once a year, in December, in two parts, "U.S." and "DX Listings"

Supplements to both editions appear at quarterly intervals, obtainable by prior order direct from the publishers.

We supply the "Call Book" as an annual publication, as required at any time during the year. We shall not be handling the quarterly supplements. These will be available only direct from the publishers.

This comprehensive reference lists about 300,000 licensed radio amateurs in the United States Directory and 160,000 or more in the rest of the world (contained in the "DX Section"). In the U.S. Section, licence classifications are shown with revised listings of new licences, names and addresses. The CALLBOOK also includes much incidental DX information. Every amateur operator and SWL needs the CALLBOOK to get the most out of Amateur Radio.

DX Listings £2-95

U.S. Listings £3-75

The above prices include postage and packing.

Your order to:

Publications Dept.,

**SHORT WAVE MAGAZINE**

55 Victoria Street, London, SW1H 0HF

01-222 5341